

Rev.	Revision note	Date	Drawing By	Check By	Approved By
A	NEW DRAWING ISSUE.	11/26/15	Mindy		

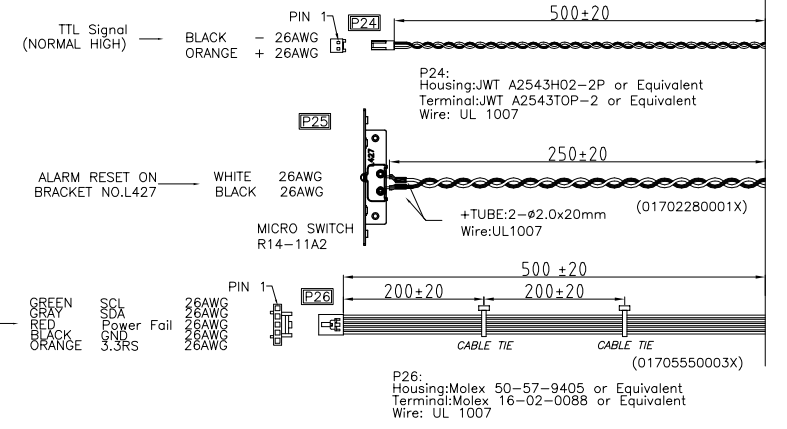
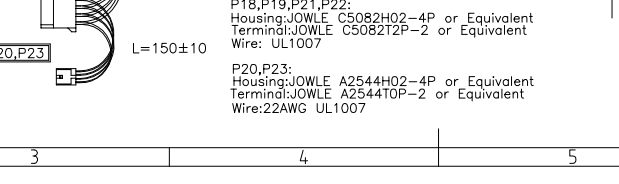
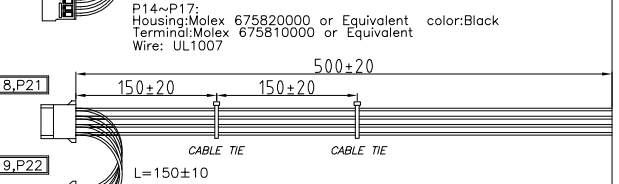
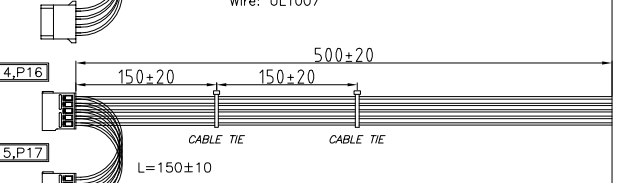
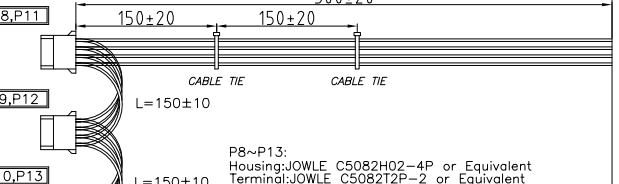
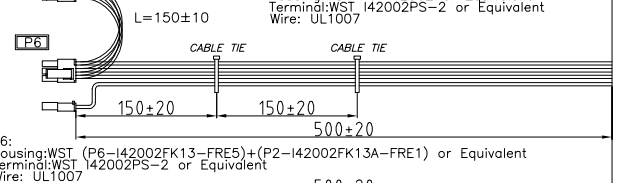
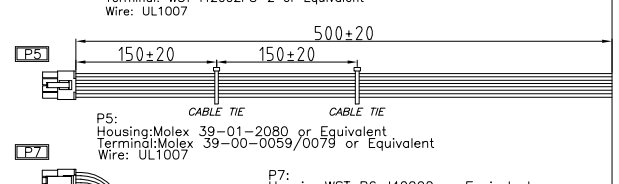
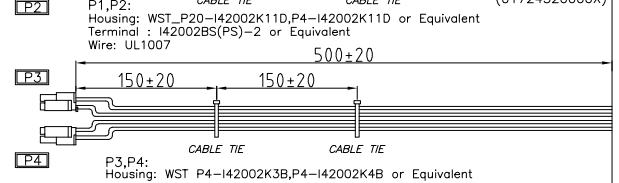
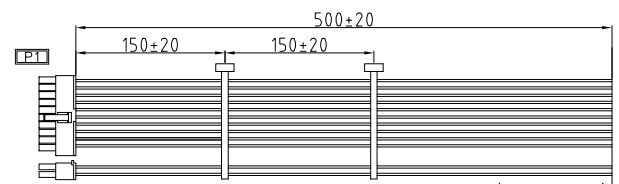
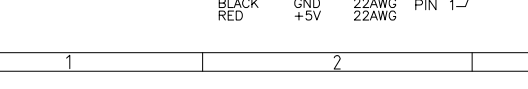
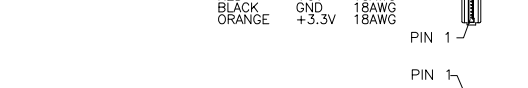
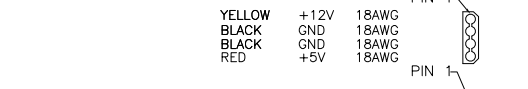
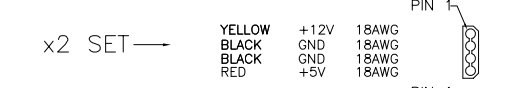
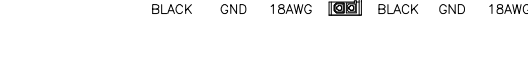
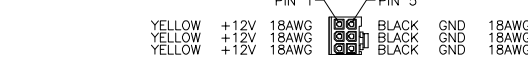
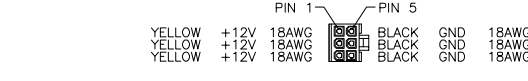
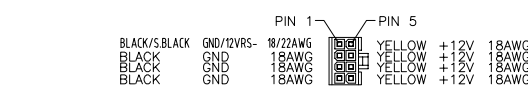
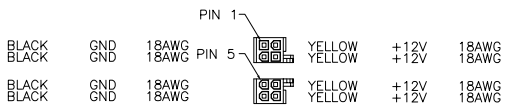
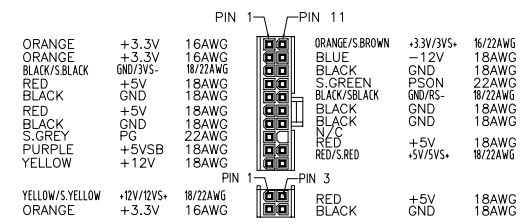

CUSTOMER APPROVED

NOTES:
1. Tolerances: ±20mm

MODEL IX-550R2UPD8	NAME Wireharness	 Powered by StarUSA Group	UNIT mm	SCALE
NOTES TOLERANCE TO BE FOLLOWINGS UNLESS OTHERWISE BE SPECIFIED	MATERIAL Wireharness			SHEET 1 of 1
LENGTH 0-500mm(Included) ±20mm OVER 500mm ±30mm	FINISH	PART NO.		DRAWING NO.
MANUFACTURE NUMBER				

Rev.	Revision note	Date	Drawing By	Check By	Approved By
A	NEW DRAWING ISSUE.	11/26/15	Mindy		

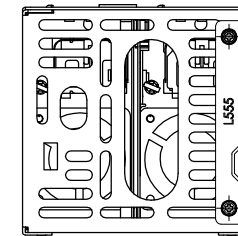
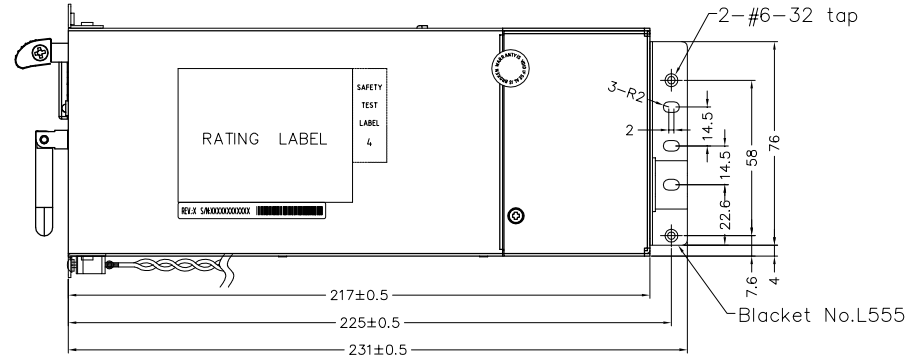
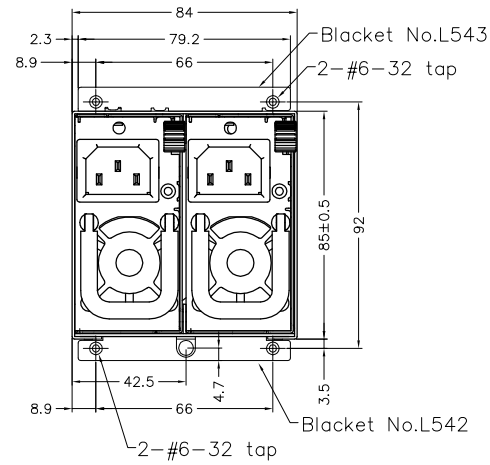
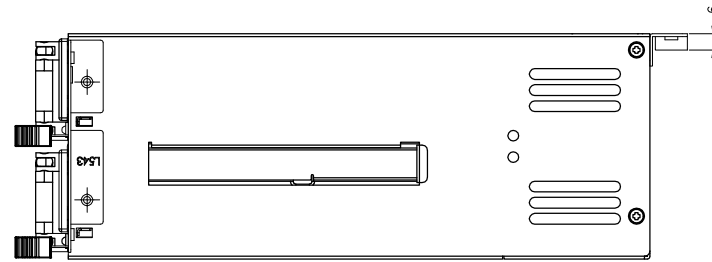

CUSTOMER APPROVED

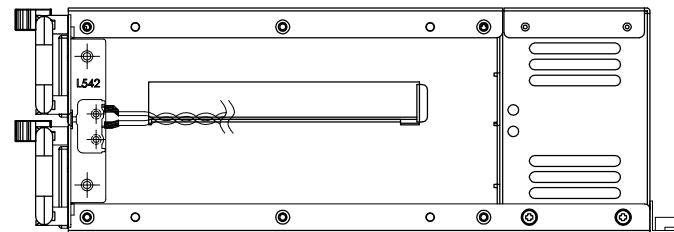

NOTES:
1.Tolerances:±0.5mm

支 架 附 件	支 架 附 件
L542x1	L543x1
L543x1	L555x1

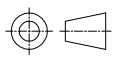
MODEL IX-550R2UPD8	NAME Outside Dim	 Powered by iStarUSA Group			
NOTES TOLERANCE UNLESS OTHERWISE MARKED					
GENERAL TOLERANCE		MATERIAL	UNIT	mm	SCALE
LENGTH	FOR NCT FOR MODEL	FINISH		1 of 1	SHEET
0~30mm	±0.3mm ±0.1mm	PART NO.			
30~70mm	±0.35mm ±0.15mm	MANUFACTURE NUMBER	DRAWING NO.		
70~120mm	±0.4mm ±0.2mm				
OVER 125mm	±0.5mm ±0.25mm				