



IAGE820-ISCSI  
MAGE208U20-ISCSI  
MAGE316U20-ISCSI

**iSCSI GbE to SATA II RAID Storage**

# **User Manual**

# Preface

## About this manual

This manual is the introduction of **iStarUSA's Tower and 2U/3U rackmount iSCSI GbE Raid Storage Solution** and it aims to help users know the operations of the disk array system easily. Information contained in this manual has been reviewed for accuracy, but not for product warranty because of the various environments/OS/settings, Information and specification will be changed without further notice. For any update information, please visit [www.istarusa.com](http://www.istarusa.com) and your contact windows.

Thank you for using **iStarUSA, Inc.** products; if you have any question, please e-mail to "tech@istarusa.com". We will answer your question as soon as possible.

## Product Description

### Panel layout

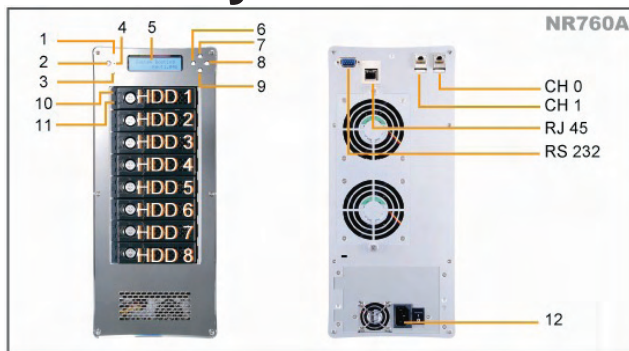

1. Power LED
2. Mute Button  
Reset for Buzzer Beeping
3. Temperature LED  
Normal – Green;  
Fail – Red (too slow rpm or stop)

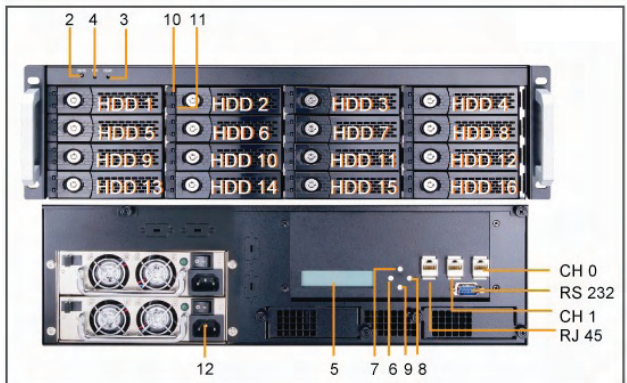
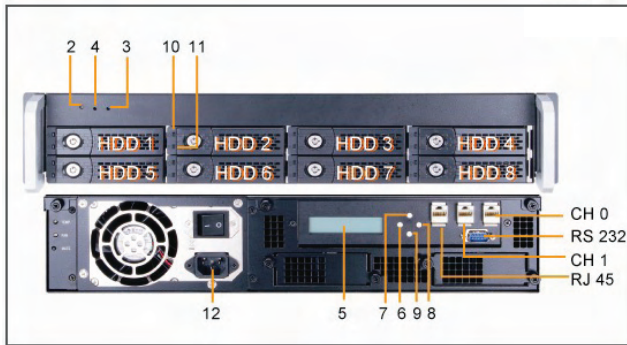

- 4. Fan Status LED  
Normal – Green; Over 55°C – Red
  - 5. LCM
  - 6. Back (Control button)
  - 7. Up (Control button)
  - 8. Enter (Control button)
  - 9. Down (Control button)
  - 10. HDD Power LED
  - 11. HDD Status LED
  - 12. Power Cord Receptacle
- \*CH 0, CH 1  
Gigabit Ethernet ports
- \*RJ 45  
Ethernet port for management
- \*RS 232  
Consol port

## Disk Installation

Install each Hard Drive into the Drive Trays and fasten using the supplied HDD screws.

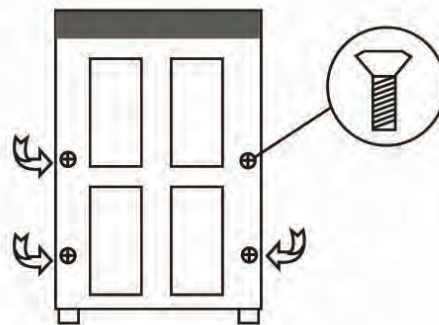
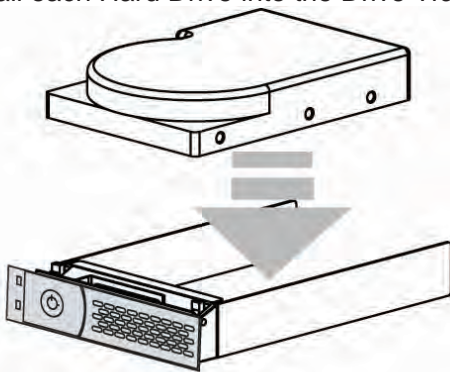

**Attach screws**

## System Connection

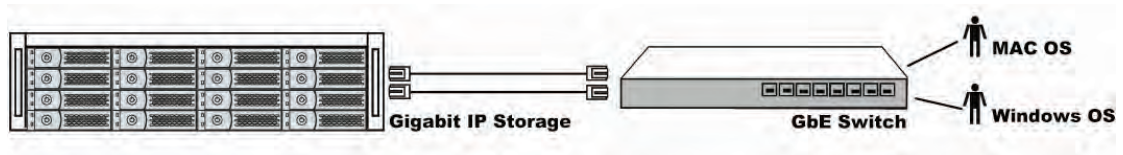

1. Connect CH0, CH1 to GbE switching ports for data transmission.
- 2.. Connect RJ45 to Ethernet port for management.



## Table of Contents

1.1	Features .....	7
1.2	Terminology .....	8
1.3	RAID levels .....	10
1.4	Volume relationship diagram.....	12
<b>Chapter 2</b>	<b>Getting started .....</b>	<b>13</b>
2.1	Before starting.....	13
2.2	iSCSI introduction .....	13
2.3	Management methods .....	15
2.3.1	Web GUI.....	16
2.3.2	Remote control – secure shell .....	16
2.4	Enclosure .....	17
2.4.1	LCM.....	17
2.4.2	System buzzer.....	20
2.4.3	LED .....	20
<b>Chapter 3</b>	<b>Web GUI guideline.....</b>	<b>22</b>
3.1	Web GUI hierarchy .....	22
3.2	Login .....	23
3.3	Quick install.....	24
3.4	System configuration .....	26
3.4.1	System name .....	27
3.4.2	IP address .....	27
3.4.3	Language .....	28
3.4.4	Login config .....	28
3.4.5	Password.....	29
3.4.6	Date.....	29
3.4.7	Mail.....	30
3.4.8	SNMP .....	31
3.4.9	Messenger.....	32
3.4.10	System log server.....	32
3.4.11	Event log .....	33
3.5	iSCSI config .....	34
3.5.1	Entity property .....	35
3.5.2	NIC .....	35
3.5.3	Node.....	36
3.5.4	Session.....	38
3.5.5	CHAP account.....	39

3.6	Volume configuration .....	39
3.6.1	Physical disk.....	40
3.6.2	Volume group .....	43
3.6.3	User data volume .....	45
3.6.4	Cache volume .....	47
3.6.5	Logical unit number .....	48
3.6.6	Example .....	50
3.7	Enclosure management .....	60
3.7.1	SES configuration.....	61
3.7.2	Hardware monitor .....	62
3.7.3	Hard drive S.M.A.R.T. support .....	63
3.8	System maintenance .....	64
3.8.1	Upgrade.....	65
3.8.2	Info .....	65
3.8.3	Reset to default .....	66
3.8.4	Config import & export.....	66
3.8.5	Shutdown .....	67
3.9	Logout .....	67
<b>Chapter 4</b>	<b>Advanced operation .....</b>	<b>68</b>
4.1	Rebuild.....	68
4.2	VG migration and expansion.....	70
4.3	UDV Extension.....	73
4.4	Disk roaming .....	74
4.5	Support Microsoft MPIO and MC/S.....	74
<b>Appendix</b>	<b>.....</b>	<b>76</b>
A.	Certification list.....	76
B.	Event notifications.....	78
C.	Known issues.....	84
D.	Microsoft iSCSI Initiator.....	84
E.	Installation steps for large volume (TB).....	86
F.	MPIO and MC/S setup instructions.....	91

# Chapter 1 RAID introduction

## 1.1 Features

**iStarUSA iSCSI series** is a high-performance RAID solution including the following Models

- **iAge820-iSCSI** : Desktop 8 bay iSCSI(Host) to SATA II (Disk) Raid Storage
- **mAge208U20-iSCSI** : 2U-8 bay iSCSI (Host) to SATA II (Disk) Raid Storage
- **mAge316U20-iSCSI** : 3U-16 bay iSCSI (Host) to SATA II (Disk) Raid Storage

**iStarUSA iSCSI** storage solution features:

- Front-end 2 ports GbE NIC ports with load-balancing & fail-over for high availability.
- iSCSI jumbo frame support.
- RAID 0, 1, 0+1, 3, 5, 6, 50, 60, & JBOD ready.
- SATA II drive backward-compatible.
- One logic volume can be shared by as many as 32 hosts.
- Host access control.
- Configurable N-way mirror for high data protection.
- On-line volume migration with no system down-time.
- HDD S.M.A.R.T. enabled for SATA drives.
- Global/dedicated cache configurable by volume.

With proper configuration, **iStarUSA** product can provide non-stop service with a high degree of fault tolerance by using RAID technology and advanced array management features. Should you have any question, please feel free to contact your local sales representative or directly send email to [tech@istarusa.com](mailto:tech@istarusa.com)

**iSCSI** GbE enclosure connects to the host system via iSCSI interface. It can be configured to any RAID level. The controller provides reliable data protection for servers and **RAID 6**. RAID 6 allows two HDD failures without producing any impact on the existing data. Data can be recovered from the existing data and parity drives. (Data can be recovered from the rest disks/drives.)

**iStarUSA's** iSCSI solution is the most cost-effective disk array controller with completely integrated high-performance and data-protection capabilities which meet or exceed the highest industry standards, and **the best data solution for small/medium business (SMB) users.**

## 1.2 Terminology

The document uses the following terms:

<b>RAID</b>	RAID is the abbreviation of “ <b>R</b> edundant <b>A</b> rray of <b>I</b> ndependent <b>D</b> isks”. There are different RAID levels with different degree of the data protection, data availability, and performance to host environment.
<b>PD</b>	The <b>P</b> hysical <b>D</b> isk belongs to the member disk of one specific volume group.
<b>VG</b>	<b>V</b> olume <b>G</b> roup. A collection of removable media. One VG consists of a set of UDVs and owns one RAID level attribute.
<b>UDV</b>	<b>U</b> ser <b>D</b> ata <b>V</b> olume. Each VG could be divided into several UDVs. The UDVs from one VG share the same RAID level, but may have different volume capacity.
<b>CV</b>	<b>C</b> ache <b>V</b> olume. Controller uses onboard memory as cache. All RAM (except for the part which is occupied by the controller) can be used as cache.
<b>LUN</b>	<b>L</b> ogical <b>U</b> nit <b>N</b> umber. A logical unit number (LUN) is a unique identifier which enables it to differentiate among separate devices (each one is a logical unit).
<b>GUI</b>	<b>G</b> raphic <b>U</b> ser <b>I</b> nterface.
<b>RAID width, RAID copy,</b>	RAID width, copy and row are used to describe one VG. E.g.:

<b>RAID row</b> (RAID cell in one row)	<ol style="list-style-type: none"> <li>1. One 4-disk RAID 0 volume: RAID width= 4; RAID copy=1; RAID row=1.</li> <li>2. One 3-way mirroring volume: RAID width=1; RAID copy=3; RAID row=1.</li> <li>3. One RAID 10 volume over 3 4-disk RAID 1 volume: RAID width=1; RAID copy=4; RAID row=3.</li> </ol>
<b>WT</b>	<b>Write-Through</b> cache-write policy. A caching technique in which the completion of a write request is not signaled until data is safely stored in non-volatile media. Each data is synchronized in both data cache and accessed physical disks.
<b>WB</b>	<b>Write-Back</b> cache-write policy. A caching technique in which the completion of a write request is signaled as soon as the data is in cache and actual writing to non-volatile media occurs at a later time. It speeds up system write performance but needs to bear the risk where data may be inconsistent between data cache and the physical disks in one short time interval.
<b>RO</b>	Set the volume to be <b>Read-Only</b> .
<b>DS</b>	<b>Dedicated Spare</b> disks. The spare disks are only used by one specific VG. Others could not use these dedicated spare disks for any rebuilding purpose.
<b>GS</b>	<b>Global Spare</b> disks. GS is shared for rebuilding purpose. If some VGs need to use the global spare disks for rebuilding, they could get the spare disks out from the common spare disks pool for such requirement.
<b>DC</b>	<b>Dedicated Cache</b> .
<b>GC</b>	<b>Global Cache</b> .
<b>DG</b>	<b>DeGraded</b> mode. Not all of the array's member disks are functioning, but the array is able to respond to application

	read and write requests to its virtual disks.
<b>SCSI</b>	<b>S</b> mall <b>C</b> omputer <b>S</b> ystems <b>I</b> nterface.
<b>iSCSI</b>	<b>I</b> nternet <b>S</b> mall <b>C</b> omputer <b>S</b> ystems <b>I</b> nterface.
<b>S.M.A.R.T.</b>	<b>S</b> elf- <b>M</b> onitoring <b>A</b> nalysis and <b>R</b> eporting <b>T</b> echnology.
<b>WWN</b>	<b>W</b> orld <b>W</b> ide <b>N</b> ame.
<b>HBA</b>	<b>H</b> ost <b>B</b> us <b>A</b> dapter.
<b>SAF-TE</b>	<b>S</b> CSI <b>A</b> ccessed <b>F</b> ault- <b>T</b> olerant <b>E</b> nclosures.
<b>NIC</b>	<b>N</b> etwork <b>I</b> nterface <b>C</b> ard.
<b>LACP</b>	<b>L</b> ink <b>A</b> ggregation <b>C</b> ontrol <b>P</b> rotocol.
<b>MPIO</b>	<b>M</b> ulti- <b>P</b> ath <b>I</b> nput/ <b>O</b> utput.
<b>MC/S</b>	<b>M</b> ultiple <b>C</b> onnections per <b>S</b> ession
<b>MTU</b>	<b>M</b> aximum <b>T</b> ransmission <b>U</b> nit.
<b>CHAP</b>	<b>C</b> hallenge <b>H</b> andshake <b>A</b> uthentication <b>P</b> rotocol. An optional security mechanism to control access to an iSCSI storage system over the iSCSI data ports.
<b>iSNS</b>	<b>I</b> nternet <b>S</b> torage <b>N</b> ame <b>S</b> ervice.

### 1.3 RAID levels

<b>RAID 0</b>	Disk striping. RAID 0 needs at least one hard drive.
---------------	--

<b>RAID 1</b>	Disk mirroring over two disks. RAID 1 needs at least two hard drives.
<b>N-way mirror</b>	Extension to RAID 1 level. It has N copies of the disk.
<b>RAID 3</b>	Striping with parity on the dedicated disk. RAID 3 needs at least three hard drives.
<b>RAID 5</b>	Striping with interspersed parity over the member disks. RAID 3 needs at least three hard drives.
<b>RAID 6</b>	2-dimensional parity protection over the member disks. RAID 6 needs at least four hard drives.
<b>RAID 0+1</b>	Mirroring of the member RAID 0 volumes. RAID 0+1 needs at least four hard drives.
<b>RAID 10</b>	Striping over the member RAID 1 volumes. RAID 10 needs at least four hard drives.
<b>RAID 30</b>	Striping over the member RAID 3 volumes. RAID 30 needs at least six hard drives.
<b>RAID 50</b>	Striping over the member RAID 5 volumes. RAID 50 needs at least six hard drives.
<b>RAID 60</b>	Striping over the member RAID 6 volumes. RAID 60 needs at least eight hard drives.
<b>JBOD</b>	The abbreviation of “ <b>J</b> ust a <b>B</b> unch <b>O</b> f <b>D</b> isks”. JBOD needs at least one hard drive.

## 1.4 Volume relationship diagram

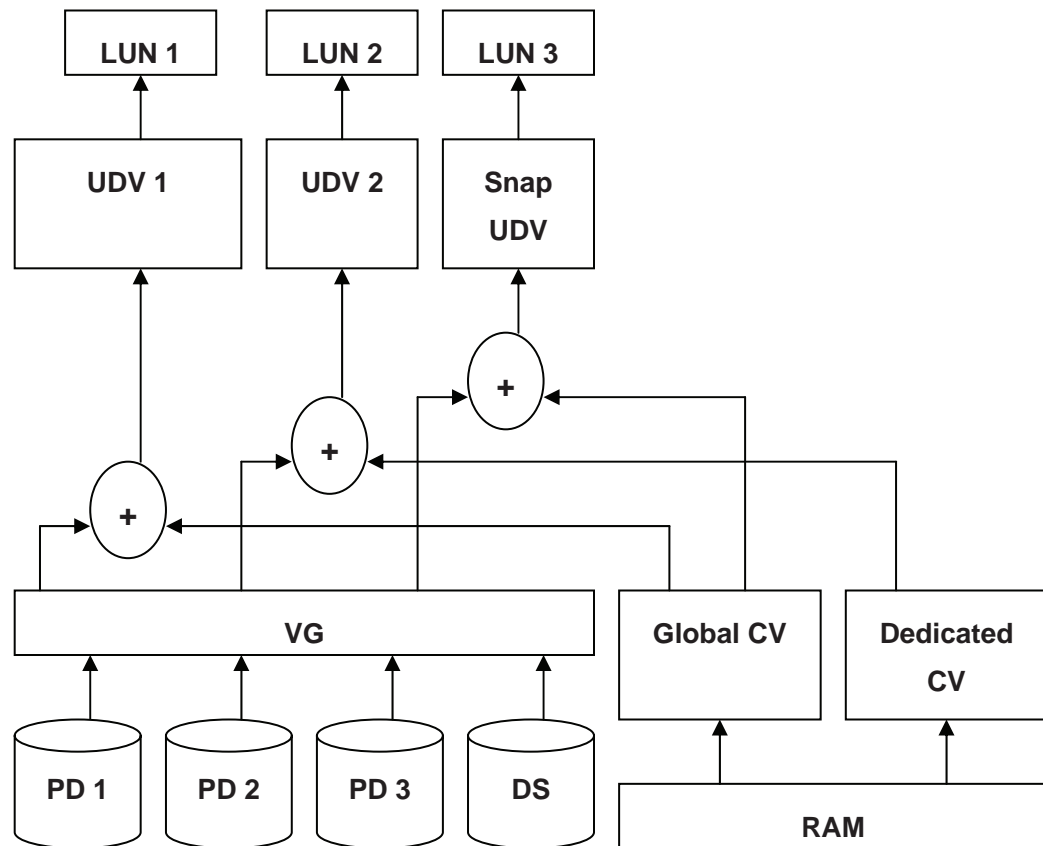

Figure 1.4.1

This is the volume structure of **Netstor** designed. It describes the relationship of RAID components. One VG (Volume Group) consists of a set of UDVs (User Data Volume) and owns one RAID level attribute. Each VG can be divided into several UDVs. The UDVs in one VG share the same RAID level, but may have different volume capacity. Each UDV will be associated with one specific CV (Cache Volume) to execute the data transaction. Each CV can have different cache memory size by user's modification/setting. LUN (Logical Unit Number) is a unique identifier, in which users can access through SCSI commands.



# Chapter 2 Getting started

## 2.1 Before starting

Before starting, prepare the following items.

1. Check “**Certification list**” in Appendix A to confirm the hardware setting is fully supported.
2. Read the latest release note before upgrading. Release note accompany with release firmware.
3. A server with a NIC or iSCSI HBA.
4. CAT 5e, or CAT 6 network cables for management port and iSCSI data ports. Recommend CAT 6 cables for best performance.
5. Prepare storage system configuration plan.
6. Management and iSCSI data ports network information. When using static IP, please prepare static IP addresses, subnet mask, and default gateway.
7. Gigabit LAN switches. (recommended) Or Gigabit LAN switches with VLAN/LCAP/Trunking functions. (optional)
8. CHAP security information, including CHAP username and password. (optional)
9. Setup the hardware connection before power on servers and **Netstor** iSCSI storage. Connect console cable, management port cable, and iSCSI data port cables in advance.

## 2.2 iSCSI introduction

iSCSI (Internet SCSI) is a protocol which encapsulates SCSI (Small Computer System Interface) commands and data in TCP/IP packets for linking storage devices with servers over common IP infrastructures. iSCSI provides high performance SANs over standard IP networks like LAN, WAN or the Internet.

IP SANs(Storage Area Networks) allow few servers to attach to an infinite

number of storage volumes by using iSCSI over TCP/IP networks. IP SANs can scale the storage capacity with any type and brand of storage system. In addition, it can be used by any type of network (Ethernet, Fast Ethernet, and Gigabit Ethernet) and combination of operating systems (Microsoft Windows, Linux, Solaris, etc.) within the SAN network. IP-SANs also include mechanisms for security, data replication, multi-path and high availability.

Storage protocol, such as iSCSI, has “two ends” in the connection. These ends are initiator and target. In iSCSI, we call them iSCSI initiator and iSCSI target. The iSCSI initiator requests or initiates any iSCSI communication. It requests all SCSI operations like read or write. An initiator is usually located on the host/server side (either an iSCSI HBA or iSCSI SW initiator).

The target is the storage device itself or an appliance which controls and serves volumes or virtual volumes. The target is the device which executes SCSI commands or plays a role as the bridge to an attached storage device.

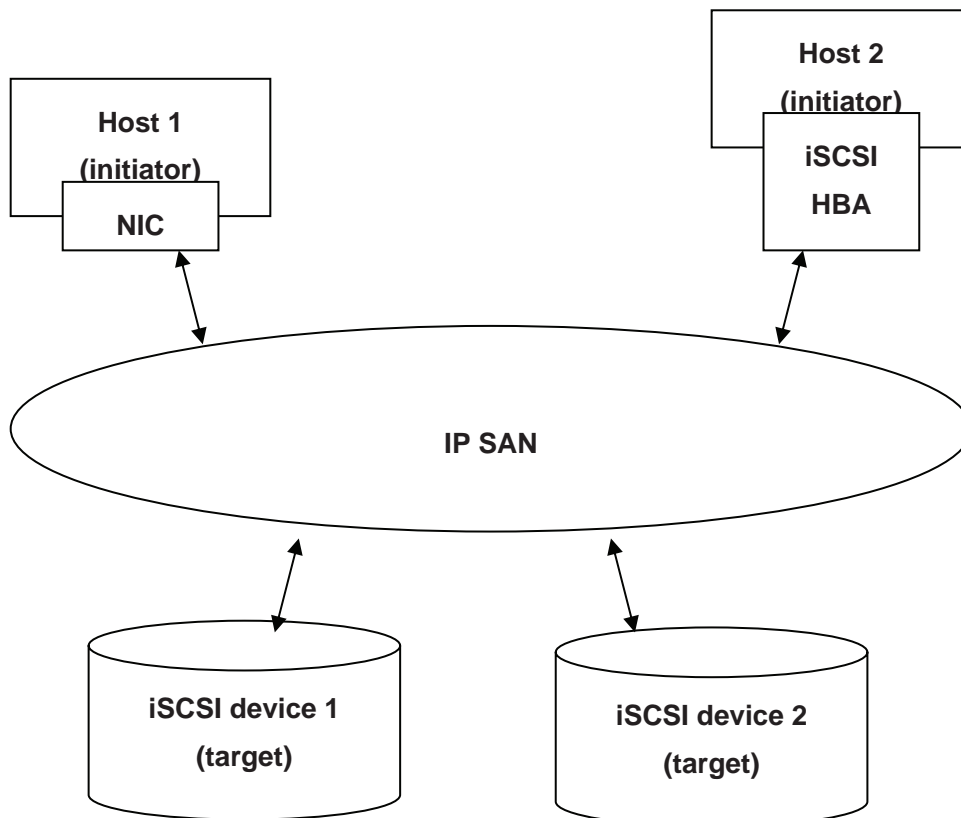

Figure 2.2.1

The host side needs an iSCSI initiator. The initiator is a driver which handles the SCSI traffic over iSCSI. The initiator can be software or hardware (HBA).

Please refer to the certification list of iSCSI HBA(s) in Appendix A. OS native initiators or other software initiators use standard TCP/IP stack and Ethernet hardware, while iSCSI HBA(s) use their own iSCSI and TCP/IP stacks on board.

Hardware iSCSI HBA(s) provide its own initiator tool. Please refer to the vendors' HBA user manual. Microsoft, Linux and Mac provide iSCSI initiator driver. Below are the available links:

1. Link to download the Microsoft iSCSI software initiator:  
<http://www.microsoft.com/downloads/details.aspx?FamilyID=12cb3c1a-15d6-4585-b385-befd1319f825&DisplayLang=en>

Please refer to Appendix D for Microsoft iSCSI initiator installation procedure.

2. Linux iSCSI initiator is also available. For different kernels, there are different iSCSI drivers. Please check Appendix A for iSCSI initiator certification list. If user needs the latest Linux iSCSI initiator, please visit Open-iSCSI project for most update information. Linux-iSCSI (sfnet) and Open-iSCSI projects merged in April 11, 2005.

**Open-iSCSI website:** <http://www.open-iscsi.org/>

**Open-iSCSI README:** <http://www.open-iscsi.org/docs/README>

**Google groups:**

<http://groups.google.com/group/open-iscsi/threads?gvc=2>

<http://groups.google.com/group/open-iscsi/topics>

3. ATTO iSCSI initiator is available for Mac.

**Website:** <http://www.attotech.com/xtend.html>

## 2.3 Management methods

There are three management methods to manage **iStarUSA** iSCSI storage, described in the following:

### 2.3.1 Web GUI

**iStarUSA** iSCSI storage support graphic user interface(GUI) to manage the system. Be sure to connect LAN cable. The default setting of management port IP is DHCP and DHCP address displays on LCM; user can inspect LCM for IP first, then open the browser and type the DHCP address: (The DHCP address is dynamic and user may need to check every time after reboot.) When DHCP service is not available, controllers use zero configuration (Zeroconf) to get an IP address.

Take an example on LCM:

192.168.1.1 GbE iSCSI Storage
----------------------------------

<http://192.168.1.1>

Click any function at the first time; it will pop up a dialog to authenticate current user.

Login name: **admin**

Default password: **1234**

Or login with read-only account which only allows to read the configuration but cannot change setting.

Login name: **user**

Default password: **1234**

### 2.3.2 Remote control – secure shell

SSH (secure shell) is required for administrators to login from a remote location. The SSH client software is available at the following web site:

SSHWinClient WWW: <http://www.ssh.com/>

Putty WWW: <http://www.chiark.greenend.org.uk/>

Host name: **192.168.1.1** (Please check your DHCP address for this field.)

Login name: **admin**  
Default password: **1234**

	<b>Tips</b> <u>iStarUSA iSCSI storage only support SSH for remote control.</u> <u>For using SSH, the IP address and password are required for</u>
---	---

## 2.4 Enclosure

### 2.4.1 LCM

There are four buttons to control **iStarUSA** LCM (LCD Control Module), including: ▲ (up), ▼ (down), **ESC** (Escape), and **ENT** (Enter).

After booting up the system, the following screen shows management port IP and model name:

192.168.XX.XX GbE iSCSI Storage ←
---

Press “**ENT**”, the LCM functions “**Alarm Mute**”, “**Reset/Shutdown**”, “**Quick Install**”, “**View IP Setting**”, “**Change IP Config**” and “**Reset to Default**” will rotate by pressing ▲ (up) and ▼ (down).

When there is WARNING or ERROR occurred (LCM default filter), the LCM shows the event log to give users more detail from front panel.

The following table is the function description.

<b>Alarm Mute</b>	Mute alarm when error occurs.
<b>Reset/Shutdown</b>	Reset or shutdown controller.

<b>Quick Install</b>	Quick steps to create a volume. Please refer to next chapter for operation in web UI.
<b>View IP Setting</b>	Display current IP address, subnet mask, and gateway.
<b>Change IP Config</b>	Set IP address, subnet mask, and gateway. There are 2 options: DHCP (Get IP address from DHCP server) or static IP.
<b>Reset to Default</b>	<p>Reset to default sets password to default: <b>1234</b>, and set IP address to default as DHCP setting.</p> <p>Default IP address: <b>192.168.1.1</b> (DHCP)</p> <p><b>Default subnet mask: 255.255.255.0</b></p> <p>Default gateway: <b>192.168.1.1</b></p>

The following is LCM menu hierarchy.

<p style="text-align: center;">Netstor Technology ▲▼</p>	[Alarm Mute]	[▲Yes No▼]		
	[Reset/Shutdown]	[Reset]	[▲Yes No▼]	
		[Shutdown]	[▲Yes No▼]	
	[Quick Install]	RAID 0	[Volume Size]	Adjust Volume
		RAID 1	xxx GB	Size
		RAID 3	[Apply The Config]	[▲Yes No▼]
		RAID 5		
		RAID 6		
	RAID 0+1			
	xxx GB			
	[View IP Setting]	[IP Config]		
		[Static IP]		
		[IP Address]		
[192.168.1.1]				
	[IP Subnet Mask]			
	[255.255.255.0]			
	[IP Gateway]			
	[192.168.010.254]			
[Change IP Config]	[DHCP]	[▲Yes No▼]		
	[Static IP]	[IP Address]	Adjust IP address	
		[IP Subnet Mask]	Adjust Submask IP	
		[IP Gateway]	Adjust Gateway IP	
		[Apply IP Setting]	[▲Yes No▼]	
[Reset to Default]	[▲Yes No▼]			



**Caution**  
Before power off, it is better to execute “**Shutdown**” to flush the data from cache to physical disks.

## 2.4.2 System buzzer

The system buzzer features are listed below:

1. The system buzzer alarms 1 second when system boots up successfully.
2. The system buzzer alarms continuously when there is an error occurred. The alarm will be stopped after the error is cleared or the alarm is muted.
3. The alarm will be muted automatically when the error is cleared. E.g., when RAID 5 is degraded then the alarm rings immediately, user changes/adds one physical disk for rebuilding. When the rebuilding is done, the alarm will be muted automatically.

## 2.4.3 LED

The LED features are listed below:

1. **Marquee / Disk Status / Disk Rebuilding LED:** The Marquee / Disk Status / Disk Rebuilding LEDs are displayed with same LEDs. The LEDs indicates different functions in different stages.
  - I. **Marquee LEDs:** When the system successfully boots up, the Marquee LED is on until the system boots successfully.
  - II. **Disk status LEDs:** the LEDs reflect the disk status for the tray. Only On/Off situation.
  - III. **Disk rebuilding LEDs:** the LEDs are blinking when the disks are under rebuilding.
2. **Disk Access LED:** Hardware activated LED when accessing disks (IO).
3. **Disk Power LED:** Hardware activated LED when the disks are plugged in and powered on.
4. **System status LED:** Used to reflect the system status, when turned on, there is an error or a RAID malfunction occurred.
5. **Management LAN port LED:** GREEN LED is for LAN transmit/receive indication. ORANGE LED is for LAN port 10/100 LINK indication.
6. **BUSY LED:** Hardware activated LED when the front-end channel is busy.



7. **POWER LED:** Hardware activated LED when system is powered on.

# Chapter 3 Web GUI guideline

## 3.1 Web GUI hierarchy

The below table is the hierarchy of web GUI.

<b>Quick Install</b>	→ Step 1 / Step 2 / Step 3 / Confirm
<b>System Config</b>	
<b>System name</b>	→ System name
<b>IP address</b>	→ DHCP / Static / Address / Mask / Gateway / DNS / HTTP port / HTTPS port / SSH port
<b>Language</b>	→ Language
<b>Login config</b>	→ Auto logout / Login lock
<b>Password</b>	→ Old password / Password / Confirm
<b>Date</b>	→ Time zone / Date / Time / NTP Server
<b>Mail</b>	→ Mail-from address / Mail-to address / Sent events / SMTP relay / SMTP server / Authentication / Account / Password / Confirm / Send test mail
<b>SNMP</b>	→ SNMP trap address / Community / Send events
<b>Messenger</b>	→ Messenger IP/hostname / Send events
<b>System log server</b>	→ Server IP/hostname / Port / Facility / Event level
<b>Event log</b>	→ Filter / Download / Mute / Clear
<b>iSCSI config</b>	
<b>Entity Property</b>	→ Entity name / iSNS IP
<b>NIC</b>	→ Aggregation / IP settings for iSCSI ports / Become default gateway / Set MTU
<b>Node</b>	→ Change Authentication
<b>Session</b>	→ Delete
<b>CHAP account</b>	→ Create /Delete
<b>Volume config</b>	
<b>Physical disk</b>	→ Free disks / Global spares / Dedicated spares / More information / Auto Spindown
<b>Volume group</b>	→ Create / Delete / More information / Rename / Migrate
<b>User data</b>	→ Attach / Create / Delete / More information / Rename /
<b>Volume</b>	→ Extend / Set read/write mode / Set priority
<b>Cache volume</b>	→ Create / Delete / More information / Resize

**Logical unit** → Attach / Detach

## Enclosure management

**SES config** → Enable / Disable

**Hardware monitor** → Auto shutdown

**S.M.A.R.T.** → S.M.A.R.T. information  
(Only for SATA disks)

**UPS** → UPS Type / Shutdown Battery Level / Shutdown Delay  
/ Shutdown UPS

## Maintenance

**Upgrade** → Browse the firmware to upgrade / Export config

**Info** → System information

**Reset to default** → Sure to reset to factory default?

**Config import & export** → Import/Export / Import file

**Shutdown** → Reboot / Shutdown

## Logout

Sure to logout?

## 3.2 Login

**iStarUSA** iSCSI storage supports graphic user interface (GUI) to operate the system. Be sure to connect the LAN cable. The default IP setting is **DHCP**; open the browser and enter:

<http://192.168.xx.xx> (Please check the DHCP address first on LCM.)

Click any function at the first time; it will pop up a dialog for authentication.

Login name: **admin**

Default password: **1234**

After login, you can choose the functions which lists on the left side of window to setup configuration.

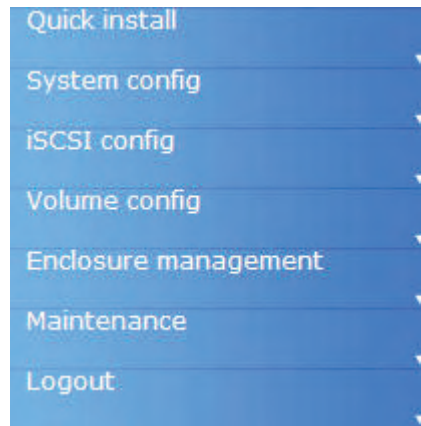





Figure 3.2.1

There are four indicators at the top-right corner.



Figure 3.2.2

1.  **RAID light:** Green means RAID works well. Red represents RAID failure.
2.  **Temperature light:** Green means normal temperature. Red represents abnormal temperature.
3.  **Voltage light:** Green means normal voltage. Red represents abnormal voltage..
4.  **UPS light:** Green means UPS works well. Red represents UPS failure.

### 3.3 Quick install

It is easy to use “**Quick install**” to create a volume. Depends on how many physical disks or how many residual spaces are free, the system will calculate

maximum spaces on RAID levels 0/1/3/5/6/0+1. “Quick install” will occupy all residual VG space for one UDV.

“**Quick Install**” has a smarter policy. When the system is inserted with some HDDs. “Quick Install” lists all possibilities and sizes in different RAID levels, it will use all available HDD for RAID level depends on user’s choose. When system has different sizes of HDDs, e.g., 8\*200G and 8\*80G, it lists all possibilities and combinations in different RAID levels and different sizes. After user sets the RAID level, user may find there are still some HDDs are available (free status). The result is using smarter policy designed by **iStarUSA**. It gives user:

1. Biggest capacity of RAID level for user to choose.
2. The fewest disk number for RAID level / volume size.

E.g., user chooses RAID 5 and the iStarUSA iSCSI Storage has 12\*200G + 4\*80G HDDs inserted. If we use all 16 HDDs for a RAID 5, and then the maximum size of volume is 1200G (80G\*15). With the wizard, we can do smarter check and find out the most efficient way of using HDDs. The wizard only uses 200G HDDs (Volume size is 200G\*11=2200G), the volume size is bigger and fully uses HDD capacity.

**Step 1:** Select “**Quick install**” and then choose the RAID level. After RAID level is chosen, click “  ”. Then it will link to next page.



Figure 3.3.1

**Step 2:** Please select a LUN number. Access control of host would show as a wildcard “\*”, which means every host can access to this volume. In this page,

the “**Volume size**” can be changed. Default value is the maximum volume size. To adjust the size, notice that it is less or equal to maximum volume size. Then click “”.

**Step 3:** Confirm page. Click “” if all configurations are correct. Then a UDV will be created.

**Done.** You can start to use the system now.

<input type="button" value="Attach"/> <input type="button" value="Create"/> <input type="button" value="Delete"/>												
<input type="checkbox"/>	No.	Name	Size (GB)	Status	1	2	3	R %	RAID	#LUN	VG name	CV (MB)
<input type="checkbox"/>	1	QUICK68809	609	Online	<input type="button" value="WB"/>	<input type="button" value="HI"/>			RAID 0	1	QUICK45427	663

**Figure 3.3.2**

(Figure 3.3.2: A RAID 0 user data volume with the UDV name “QUICK68809”, named by system itself, with the total available volume size 609GB.)

### 3.4 System configuration

“**System config**” is designed for setting up the “**System name**”, “**IP address**”, “**Language**”, “**Login config**”, “**Password**”, “**Date**”, “**Mail**”, “**SNMP**”, “**Messenger**”, “**System log server**” and view “**Event log**”.

<u>System name</u>	System name for identification	<u>System name</u>	System name for identification
<u>IP address</u>	Internet Protocol(IP) address for remote administration	<u>IP address</u>	Internet Protocol(IP) address for remote administration
<u>Language</u>	Language preference for WebUI	<u>Language</u>	Language preference for WebUI
<u>Login config</u>	Configuration for auto logout and login lock	<u>Login config</u>	Configuration for auto logout and login lock
<u>Password</u>	Administrator's password	<u>Password</u>	Administrator's password
<u>Date</u>	System time for event log	<u>Date</u>	System time for event log
<u>Mail</u>	Alert by e-mail	<u>Mail</u>	Alert by e-mail
<u>SNMP</u>	Alert via Simple Network Management Protocol(SNMP)	<u>SNMP</u>	Alert via Simple Network Management Protocol(SNMP)
<u>Messenger</u>	Transmits net send and Alert service messages between clients and servers	<u>Messenger</u>	Transmits net send and Alert service messages between clients and servers
<u>System log server</u>	Alert to remote system log server	<u>System log server</u>	Alert to remote system log server
<u>Event log</u>	System event log to record critical events	<u>Event log</u>	System event log to record critical events

Figure 3.4.1

### 3.4.1 System name

“**System name**” allows users change system name. Default “**system name**” composed of model name and serial number of this system, e.g.: P200C-A00001.

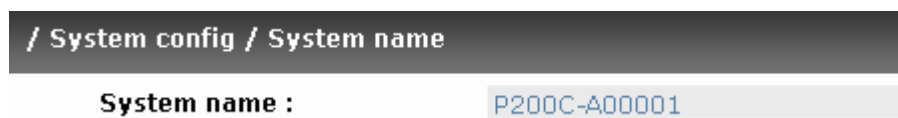
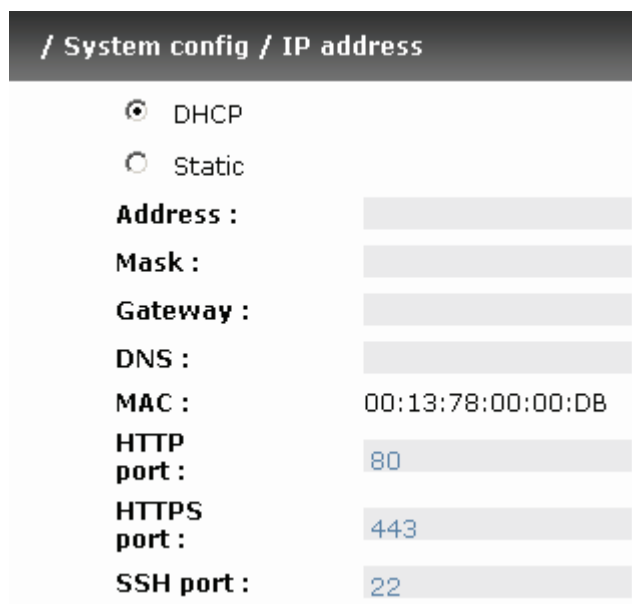

Figure 3.4.1.1

### 3.4.2 IP address

“**IP address**” allows users change IP address for remote administration. There are 2 options, DHCP (Get IP address from DHCP server) or static IP. The default setting is DHCP. User can change the HTTP, HTTPS, and SSH

port number when the default port number is not allowed on host/server.



The screenshot shows a web interface for configuring IP address settings. At the top, there is a breadcrumb trail: "/ System config / IP address". Below this, there are two radio buttons: "DHCP" (which is selected) and "Static". Underneath, there are several fields for configuration: "Address :", "Mask :", "Gateway :", and "DNS :", each followed by an empty text input field. The "MAC :" field is pre-filled with the value "00:13:78:00:00:DB". Below these are three more fields: "HTTP port :", "HTTPS port :", and "SSH port :", each followed by a text input field containing the values "80", "443", and "22" respectively.

Figure 3.4.2.1

### 3.4.3 Language

“**Language**” allows users set the language shown in Web UI. The option “Auto Detect” will set language setting by browser’s language setting.



The screenshot shows a web interface for configuring the language. At the top, there is a breadcrumb trail: "/ System config / Language". Below this, there is a label "Language :" followed by a dropdown menu. The dropdown menu is open, showing three options: "Auto Detect" (which is highlighted in blue), "English", and "Simplified Chinese".

Figure 3.4.3.1

### 3.4.4 Login config

“**Login config**” allows users set single admin and auto logout time. The single admin can prevent multiple users access the same controller at the same time.



1. **Auto logout:** The options are (1) Disable; (2) 5 minutes; (3) 30 minutes; (4) 1 hour. The system will log out automatically when user idled for a specific period of time.
2. **Login lock:** Disable/Enable. When the login lock is enabled, the system allows only one user to login or modify system settings.



Figure 3.4.4.1

### 3.4.5 Password

“**Password**” allows users change administrator password. The maximum length of admin password is 12 characters.

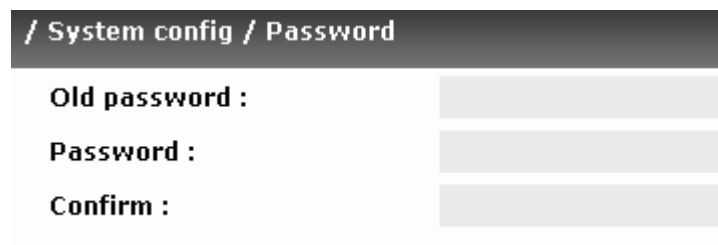

Figure 3.4.5.1

### 3.4.6 Date

“**Date**” allows users set up the current date, time, and time zone before using or synchronize time from NTP (Network Time Protocol) server.

**/ System config / Date**

**Now :** 2007/8/1 16:16:18

**Time zone :** Asia/Taipei

Setup date and time manually

**Date :** 2007 / 8 / 1

**Time :** 16 : 15 : 53

NTP

**Server :**

Figure 3.4.6.1

### 3.4.7 Mail

“**Mail**” allows users set 3 mail addresses at most to receive the event notification. Some mail servers would check “**Mail-from address**” and need authentication for anti-spam. Please fill the necessary fields and click “**Send test mail**” to test whether email functions are available. User can also select which level of event logs are needed to be sent via Mail. Default setting only enables ERROR and WARNING event logs.

/ System config / Mail	
Mail-from address :	mailman@controller
Mail-to address 1 :	
Send events 1 :	INFO <input type="checkbox"/> WARNING <input checked="" type="checkbox"/> ERROR <input checked="" type="checkbox"/>
Mail-to address 2 :	
Send events 2 :	INFO <input type="checkbox"/> WARNING <input checked="" type="checkbox"/> ERROR <input checked="" type="checkbox"/>
Mail-to address 3 :	
Send events 3 :	INFO <input type="checkbox"/> WARNING <input checked="" type="checkbox"/> ERROR <input checked="" type="checkbox"/>
SMTP relay :	<input type="checkbox"/>
SMTP server :	
Authentication :	None <input type="button" value="v"/>
Account :	
Password :	
Confirm :	
Send test mail :	<input type="checkbox"/>

Figure 3.4.7.1

### 3.4.8 SNMP

“**SNMP**” allows users set up SNMP trap for alerting via SNMP. It allows up to 3 SNMP trap addresses. Default community setting is “public”. User can choose the event log level and default setting only enables INFO event log in SNMP.

/ System config / SNMP	
SNMP trap address 1 :	
SNMP trap address 2 :	
SNMP trap address 3 :	
Community :	public
Send events :	INFO <input checked="" type="checkbox"/> WARNING <input type="checkbox"/> ERROR <input type="checkbox"/>

Figure 3.4.8.1

There are many SNMP tools. The following web sites are for your reference:

SNMPc: <http://www.snmpc.com/>

Net-SNMP: <http://net-snmp.sourceforge.net/>

### 3.4.9 Messenger

Using “**Messenger**”, user must enable the service “Messenger” in Windows (Start → Control Panel → Administrative Tools → Services → Messenger), and then event logs can be received. It allows up to 3 messenger addresses. User can choose the event log levels and default setting enables the WARNING and ERROR event logs.

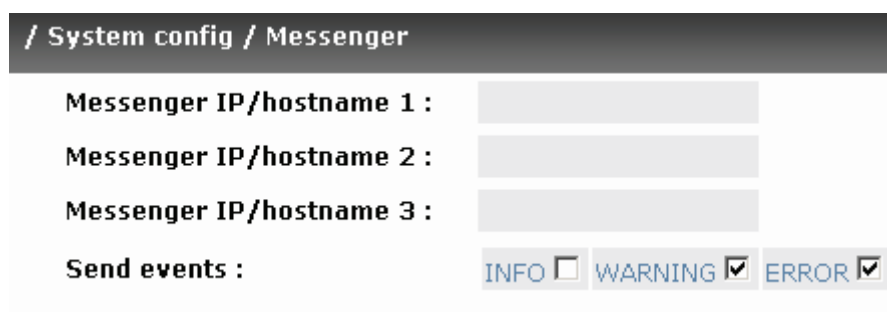

/ System config / Messenger

Messenger IP/hostname 1 :

Messenger IP/hostname 2 :

Messenger IP/hostname 3 :

Send events :

INFO

WARNING

ERROR

Figure 3.4.9.1

### 3.4.10 System log server

Using “**System log server**”, user can choose the facility and the event log level. The default port of syslog is 514. The default setting enables event level: INFO, WARNING and ERROR event logs.

**/ System config / System log server**

**Server IP/hostname :**

**Port :**

**Facility :**  ▼

**Event level :**  INFO  WARNING  ERROR

**Figure 3.4.10.1**

There are some syslog server tools. The following web sites are for your reference:

WinSyslog: <http://www.winsyslog.com/>

Kiwi Syslog Daemon: <http://www.kiwisyslog.com/>

Most UNIX systems build in syslog daemon.

### 3.4.11 Event log

“**Event log**” can view the event messages. Click “**Filter**” button to choose the level of event log display. Click “**Download**” button will save the whole event log as a text file with file name “log-ModelName-SerialNumber-Date-Time.txt” (e.g., log-P200C-A00001-20070801-120000.txt). Click “**Clear**” button will clear event log. Click “**Mute**” button will stop alarm if system alerts.

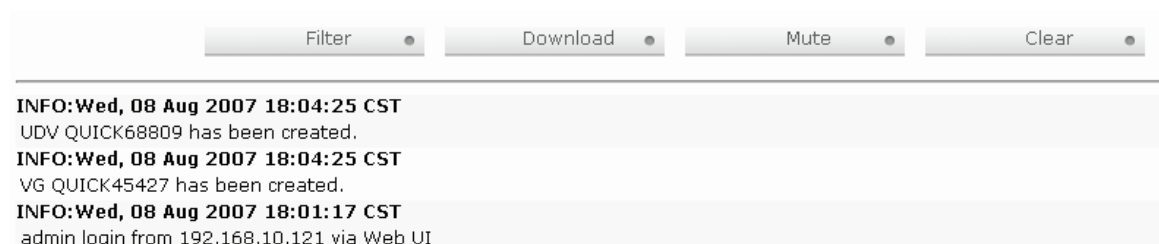

**Figure 3.4.11.1**

For customizing your own display of event logs, there are three display methods, on Web UI/Console event log page, popup windows on Web UI, and on LCM. The default setting of these three displays is WARNING and ERROR event logs displayed on Web UI and LCM. The default setting disabled the

popup function.

<b>Show events :</b>	INFO <input type="checkbox"/>	WARNING <input checked="" type="checkbox"/>	ERROR <input checked="" type="checkbox"/>
<b>Pop up events :</b>	INFO <input type="checkbox"/>	WARNING <input type="checkbox"/>	ERROR <input type="checkbox"/>
<b>Show on LCM :</b>	INFO <input type="checkbox"/>	WARNING <input checked="" type="checkbox"/>	ERROR <input checked="" type="checkbox"/>

---

<< Back      Confirm

**Figure 3.4.11.2**

The event log is displayed in reverse order which means the latest event log is on the first page. The event logs are actually saved in the first four hard drives; each hard drive has one copy of event log. For one set of Netstor iSCSI Storage, there are four copies of event logs to make sure users can check event log any time when there is/are failed disk(s).



**Tips**  
Please plug-in any of the first four hard drives, then event logs can be saved and displayed during next system boot up.

## 3.5 iSCSI config

“iSCSI config” is designed for setting up the “Entity Property”, “NIC”, “Node”, “Session”, and “CHAP account”.

<u>Entity property</u>	iSCSI entity property	<u>Entity property</u>	iSCSI entity property
<u>NIC</u>	iSCSI portal configuration	<u>NIC</u>	iSCSI portal configuration
<u>Node</u>	iSCSI node configuration	<u>Node</u>	iSCSI node configuration
<u>Session</u>	iSCSI session information	<u>Session</u>	iSCSI session information
<u>CHAP account</u>	Add/Remove account for iSCSI node	<u>CHAP account</u>	Add/Remove account for iSCSI node

**Figure 3.5.1**

### 3.5.1 Entity property

“Entity property” allows users view the entity name of the iStarUSA iSCSI Storage and setup “iSNS IP” for iSNS (Internet Storage Name Service). iSNS protocol allows automated discovery, management and configuration of iSCSI devices on a TCP/IP network. Using iSNS, it needs to install a iSNS server in SAN. Add an iSNS server IP address into iSNS server lists in order that iSCSI initiator service can send queries.

/ iSCSI config / Entity property

**Entity name :**

**iSNS IP :**

Figure 3.5.1.1

### 3.5.2 NIC

“NIC” allows users change IP addresses of iSCSI data ports. iStarUSA’s iSCSI Series has two gigabit LAN ports to transmit data.

Aggregation ●

Name	LAG	LAG No	DHCP	IP address	Netmask	Gateway	MTU	MAC address	Link
LAN1	no	N/A	no	192.168.11.216	255.255.255.0	192.168.11.254	8000	00:13:78:a8:00:02	up
LAN2	no	N/A	no	192.168.12.216	255.255.255.0	192.168.12.254	1500	00:13:78:a8:00:03	up

Entity name :

Aggregation ●

Figure 3.5.2.2

Name	DHCP	IP address	Netmask	Gateway	Jumbo frame	MAC address	Link
LAN1	No	192.168.11.105	255.255.255.0	192.168.11.254	Disabled	00:13:78:04:00:04	Up
LAN2	No	192.168.12.105	255.255.255.0	192.168.12.202	Disabled	00:13:78:04:00:05	Up

Figure 3.5.2.3

(Figure 3.5.2.3: iStarUSA iSCSI Series, there are 2 iSCSI data ports. Each of them is set to static IP.)

## IP settings:

User can change IP address by clicking the button “” in the “**DHCP**” column. There are 2 selections, DHCP (Get IP address from DHCP server) or static IP.



The screenshot shows a configuration window titled "/ iSCSI config / NIC / IP address". It features two radio buttons: "DHCP" (unselected) and "Static" (selected). Below these are three input fields: "Address" with the value "192.168.1.1", "Mask" with "255.255.255.0", and "Gateway" with "192.168.1.254".

Figure 3.5.2.5

## Default gateway:

Default gateway can be changed by clicking the button “” in the “**Gateway**” column. There is only one default gateway.

## MTU / Jumbo frame:

**MTU** (**M**aximum **T**ransmission **U**nit) size can be changed by clicking the button “” in the “**MTU**” column.



**Caution**  
The MTU size of switching hub and HBA on host must be enabled. Otherwise, the LAN connection can not work properly.

## 3.5.3 Node

“**Node**” allows users view the target name for iSCSI initiator. **iStarUSA iSCSI Series** supports single-node. The node name exists by default.



Name	Auth
iqn.2004-08.tw.com.qsan:p150c-000a8a001:default-target	None

Figure 3.5.3.1

(Figure 3.5.3.1: iStarUSA iSCSI Series, single-mode.)

### CHAP:

**CHAP** is the abbreviation of **Challenge Handshake Authorization Protocol**. CHAP is a strong authentication method used in point-to-point for user login. It's a type of authentication in which the authentication server sends the client a key to be used for encrypting the username and password. CHAP enables the username and password to transmitting in an encrypted form for protection.

To use CHAP authentication in **iSCSI Series**, please follow the procedures.

1. Click “” in Auth column.
2. Select “**CHAP**”.

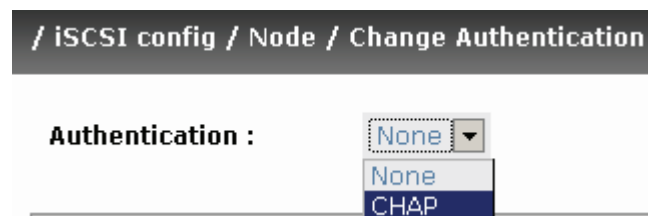



Figure 3.5.3.7

3. Click “ Confirm ”.

Name	Auth
iqn.2004-08.tw.com.qsan:p150c-000a8a001:default-target	CHAP

Figure 3.5.3.8

4. Go to “/ iSCSI config / CHAP” page to create CHAP account. Please refer to next section for more detail.
5. In “ / iSCSI config / Node / Change Authentication ”, select “**None**” to disable CHAP.



**Tips**  
After setting CHAP, the initiator in host/server should be set the

### 3.5.4 Session

“**Session**” can display iSCSI session and connection information, including the following items:

1. Host (Initiator Name)
2. Error Recovery Level
3. Error Recovery Count
4. Detail of Authentication status and Source IP: port number.

<input type="checkbox"/>	No	Initiator name	TPGT	Error recovery level	Error recovery count
<input type="checkbox"/>	0	iqn.1987-05.com.cisco:01.c047c42de54	0x02	0	0
<input type="checkbox"/>	1	iqn.1987-05.com.cisco:01.c047c42de54	0x02	0	0
<input type="checkbox"/>	2	iqn.1987-05.com.cisco:01.c047c42de54	0x00	0	0

**Figure 3.5.4.1**

(Figure 3.5.4.1: iSCSI Session.)

Clicking the button “” will display connection(s).

No.	Initiator IP	Initiator name	Authentication
0	192.168.12.212	iqn.1987-05.com.cisco:01.c047c42de54	no

**Figure 3.5.4.2**

(Figure 3.5.4.2: iSCSI Connection.)

### 3.5.5 CHAP account

“CHAP account” allows users manage a CHAP account for authentication. There is only one account only.

To setup CHAP account, please follow the procedures.

1. Click “”.
2. Enter “**User**”, “**Secret**”, and “**Confirm**” secret again.

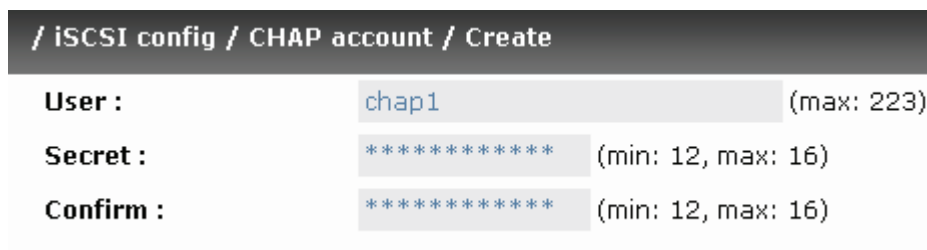

/ iSCSI config / CHAP account / Create

User : chap1 (max: 223)

Secret : \*\*\*\*\* (min: 12, max: 16)

Confirm : \*\*\*\*\* (min: 12, max: 16)

Figure 3.5.5.3

3. Click “”.

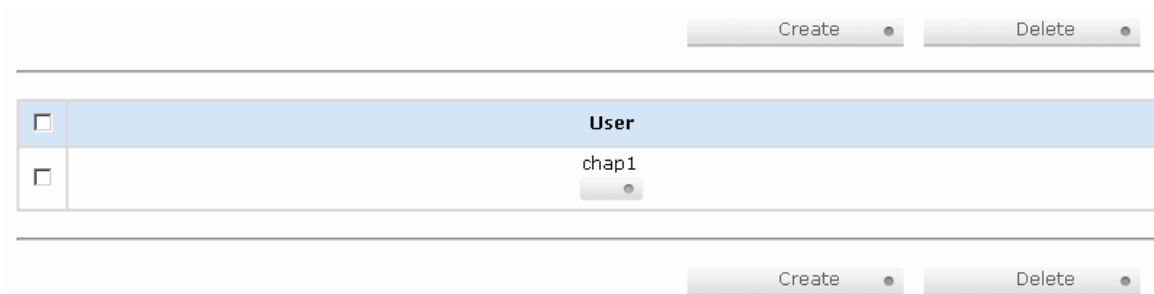

<input type="checkbox"/>	User
<input type="checkbox"/>	chap1

Figure 3.5.5.4

(Figure 3.5.5.4: iStarUSA iSCSI Storage, create a CHAP account named “chap1”.)

4. Click “” to delete CHAP account.

## 3.6 Volume configuration

“Volume config” is designed for setting up the volume configurations

including “**Physical disk**”, “**Volume group**”, “**User data volume**”, “**Cache volume**”, and “**Logical unit**”.

<b>Physical disk</b>	Hard disks to store data	<b>Physical disk</b>	Hard disks to store data
<b>Volume group</b>	Sets of physical disks with RAID functions	<b>Volume group</b>	Sets of physical disks with RAID functions
<b>User data volume</b>	Slices of volume groups	<b>User data volume</b>	Slices of volume groups
<b>Cache volume</b>	Dedicated or global cache space for user data volume	<b>Cache volume</b>	Dedicated or global cache space for user data volume
<b>Logical unit</b>	Target volumes for hosts access	<b>Logical unit</b>	Target volumes for hosts access

Figure 3.6.1

### 3.6.1 Physical disk

“**Physical disk**” to view the status of hard drives in the system. The following are operation tips:

1. Multiple selection. Select one or more checkboxes in front of the slot number. Or select the checkbox at the top left corner which will select all slots. Check again will select none.
2. The list will disappear if there is no VG or only VG of RAID 0 and JBOD. Because these RAID levels cannot be set as dedicated spare disk.
3. These three functions “**Free disks**”, “**Global spares**”, and “**Dedicated spares**” can make multiple selections.
4. The instructions of the web pages (e.g.: volume config of VG, UDV, CV, LUN pages) are the same as previous steps.

Free disks • Global spares • Dedicated spares •

<input type="checkbox"/>	Slot	WWN	Size (GB)	VG name	Status	1	2	Speed
<input type="checkbox"/>	1	2071001378a8a002	74	VG-R0	Good	RD		3.0Gb
<input type="checkbox"/>	2	207c001378a8a002	74	VG-R0	Good	RD		3.0Gb
<input type="checkbox"/>	3	207b001378a8a002	74	VG-R0	Good	RD		3.0Gb
<input type="checkbox"/>	4	207a001378a8a002	74	VG-R0	Good	RD		3.0Gb
<input type="checkbox"/>	5	2079001378a8a002	74		Good	FR		3.0Gb
<input type="checkbox"/>	6	207d001378a8a002	74	VG-R6	Good	RD		3.0Gb
<input type="checkbox"/>	7	206f001378a8a002	74	VG-R6	Good	RD		3.0Gb
<input type="checkbox"/>	8	2070001378a8a002	74	VG-R6	Good	RD		3.0Gb
<input type="checkbox"/>	9	2078001378a8a002	74	VG-R6	Good	RD		3.0Gb
<input type="checkbox"/>	10	2072001378a8a002	74		Good	FR		3.0Gb
<input type="checkbox"/>	11	2073001378a8a002	74	VG-R6	Good	DS		3.0Gb
<input type="checkbox"/>	12	2074001378a8a002	74		Good	FR		3.0Gb
<input type="checkbox"/>	13	2075001378a8a002	74		Good	FR		3.0Gb
<input type="checkbox"/>	14	2076001378a8a002	74		Good	FR		3.0Gb
<input type="checkbox"/>	15	2077001378a8a002	74		Good	FR		3.0Gb
<input type="checkbox"/>	16	20f5001378a8a002	74		Good	FR		3.0Gb

Auto spindown : [Disabled](#)

Free disks • Global spares • Dedicated spares •

Figure 3.6.1.1

(Figure 3.6.1.1: Physical disks of slot 1,2,3,4 are created for a VG named “VG-R0”. Physical disks of slot 6,7,8,9 are created for a VG named “VG-R6”. Slot 11 is set as dedicated spare disk of VG named “VG-R6”. The others are free disks.)

□ PD column description:

<b>Slot</b>	The position of hard drives. The number of slot begins from left to right at the front side. The button next to the number of slot is “ <b>More Information</b> ”. It shows the details of the hard drive.
<b>WWN</b>	<b>World Wide Name.</b>

<b>Size (GB)</b>	Capacity of hard drive.
<b>VG Name</b>	Related volume group name.
<b>Status</b>	<p>The status of hard drive.</p> <p>“<b>GOOD</b>” → the hard drive is good.</p> <p>“<b>DEFECT</b>” → the hard drive has the bad blocks.</p> <p>“<b>FAIL</b>” → the hard drive cannot work in the respective volume.</p>
<b>Status 1</b>	<p>“<b>RD</b>” → <b>RAID Disk</b>. This hard drive has been set to RAID.</p> <p>“<b>FR</b>” → <b>FR</b>ee disk. This hard drive is free for use.</p> <p>“<b>DS</b>” → <b>D</b>edicated <b>S</b>pare. This hard drive has been set to the dedicated spare of the VG.</p> <p>“<b>GS</b>” → <b>G</b>lobal <b>S</b>pare. This hard drive has been set to a global spare of all VGs.</p> <p>“<b>RS</b>” → <b>ReS</b>erve. The hard drive contains the VG information but cannot be used. It may be caused by an uncompleted VG set, or hot-plug of this disk in the running time. In order to protect the data in the disk, the status changes to reserve. It can be reused after setting it to “FR” manually.</p>
<b>Status 2</b>	<p>“<b>R</b>” → <b>Re</b>build. The hard drive is doing rebuilding.</p> <p>“<b>M</b>” → <b>M</b>igration. The hard drive is doing migration.</p>
<b>Speed</b>	<p><b>3.0G</b> → From SATA ATAPI standard, if the disk can support ATAPI IDENTIFY PACKET DEVICE command, and the speed can achieve Serial ATA Gen-2 signaling speed (3.0Gbps).</p> <p><b>1.5G</b> → From SATA ATAPI standard, if the disk can support ATAPI IDENTIFY PACKET DEVICE command, and the speed can achieve Serial</p>

	<p>ATA Gen-1 signaling speed (1.5Gbps).</p> <p><b>Unknown</b> → The disk doesn't support above command, so the speed is defined as unknown.</p>
--	---

□ **PD operations description:**

<b>Free disks</b>	Make the selected hard drive to be free for use.
<b>Global spares</b>	Set the selected hard drive(s) to global spare of all VGs.
<b>Dedicated spares</b>	Set hard drive(s) to dedicated spare of selected VGs.

In this page, iStarUSA ISCSI Storage also provides HDD auto spindown down to save power. The default setting is disabled. User can set up in physical disk page, too.



**Figure 3.6.1.2**



**Figure 3.6.1.3**

### 3.6.2 Volume group

“**Volume group**” allows users view the status of each volume group.

□ **VG column description:**

											Create	Delete
<input type="checkbox"/>	No.	Name	Total (GB)	Free (GB)	#PD	#UDV	Status	1	2	3	RAID	
<input type="checkbox"/>	1	VG-R0	297	267	4	1	Online				RAID 0	
<input type="checkbox"/>	2	VG-R6	148	128	4	1	Online				RAID 6	

Create      Delete

**Figure 3.6.2.1**

(Figure 3.6.2.1: There is a RAID 0 with 4 physical disks, named “VG-R0”, total size is 297GB, free size is 267GB, related to 1 UDV. Another is a RAID 6 with 4 physical disks, named “VG-R6”.)

<b>No.</b>	Number of volume group. The button next to the No. is “ <b>More Information</b> ” indication. It shows the details of the volume group.
<b>Name</b>	Volume group name. The button next to the Name is “ <b>Rename</b> ”.
<b>Total(GB)</b>	Total capacity of this volume group.
<b>Free(GB)</b>	Free capacity of this volume group.
<b>#PD</b>	The number of physical disks in volume group.
<b>#UDV</b>	The number of user data volumes in volume group.
<b>Status</b>	The status of volume group. “ <b>Online</b> ” → volume group is online. “ <b>Fail</b> ” → volume group is fail.
<b>Status 1</b>	“ <b>DG</b> ” → <b>DeGraded</b> mode. This volume group is not completed. The reason could be lack of one



	disk or disk failure.
<b>Status 2</b>	“R” → <b>Rebuild</b> . This volume group is doing rebuilding.
<b>Status 3</b>	“M” → <b>Migration</b> . This volume group is doing migration.
<b>RAID</b>	The RAID level of the volume group. The button next to the RAID level is “ <b>Migrate</b> ”. Click “ <b>Migrate</b> ” can add disk(s) to do expansion or change the RAID level of the Volume group.

□ **VG operations description:**

<b>Create</b>	Create a volume group
<b>Delete</b>	Delete a volume group

### 3.6.3 User data volume

“User data volume” allows users view the status of each user data volume.

<input type="button" value="Attach"/> • <input type="button" value="Create"/> • <input type="button" value="Delete"/> •												
<input type="checkbox"/>	No.	Name	Size (GB)	Status	1	2	3	R %	RAID	#LUN	VG name	CV (MB)
<input type="checkbox"/>	1	UDV-01	30	Online	WB	HI			RAID 0	1	VG-R0	663
<input type="checkbox"/>	2	UDV-02	20	Online	WB	HI	I	46%	RAID 6	1	VG-R6	663
<input type="button" value="Attach"/> • <input type="button" value="Create"/> • <input type="button" value="Delete"/> •												

Figure 3.6.3.1

(Figure 3.6.3.1: Create a UDV named “UDV-01”, related to “VG-R0”, size is 30GB, status is online, write back, high priority, related to 1 LUN, with cache volume 663MB. The other UDV is named “UDV-02”, initializing to 46%.

□ **UDV column description:**

<b>No.</b>	Number of user data volume. The button below to the UDV No. is “ <b>More Information</b> ”. It shows the details of the User data volume.
<b>Name</b>	Name of this user data volume. The button below the UDV Name is “ <b>Rename</b> ”.
<b>Size(GB)</b>	Total capacity of user data volume. The button below to the size is “ <b>Extend</b> ”.
<b>Status</b>	The status of user data volume. “ <b>Online</b> ” → user data volume is online. “ <b>Fail</b> ” → user data volume is failed.
<b>Status 1</b>	“ <b>WT</b> ” → <b>Write Through</b> . “ <b>WB</b> ” → <b>Write Back</b> . “ <b>RO</b> ” → <b>Read Only</b> . The button below to the status1 is “ <b>Set read/write mode</b> ”.
<b>Status 2</b>	“ <b>HI</b> ” → <b>High</b> priority. “ <b>MD</b> ” → <b>MiD</b> priority. “ <b>LO</b> ” → <b>LOw</b> priority. The button in below to the status2 is “ <b>Set Priority</b> ”.
<b>Status 3</b>	“ <b>I</b> ” → user data volume is being initialized. “ <b>R</b> ” → user data volume is being rebuilt. “ <b>M</b> ” → user data volume is being migrated.
<b>R %</b>	Ratio of initializing or rebuilding.

<b>RAID</b>	The levels of RAID that user data volume is using.
<b>#LUN</b>	Number of LUN(s) that user data volume is attaching.
<b>VG name</b>	The VG name of the user data volume.
<b>CV (MB)</b>	The cache volume of the user data volume.

□ **UDV operations description:**

<b>Attach</b>	Attach to a LUN.
<b>Create</b>	Create a user data volume.
<b>Delete</b>	Delete a user data volume.

### 3.6.4 Cache volume

“**Cache volume**” can view the status of cache volume.

The global cache volume is a default cache volume which is created after power on automatically, and cannot be deleted. The size of global cache is based on the RAM size. It is total memory size minus the system usage.

			Create ●	Delete ●
<input type="checkbox"/>	<b>No.</b>	<b>Size</b>	<b>UDV name</b>	
<input type="checkbox"/>	1	663	Global	
Free : 0 (MB)				
			Create ●	Delete ●

**Figure 3.6.4.1**

□ **CV column description:**

<b>No.</b>	Number of the Cache volume. The button next to the CV No. is “ <b>More Information</b> ”. It shows the details of the cache volume.
<b>Size(MB)</b>	Total capacity of the cache volume The button next to the CV size is “ <b>Resize</b> ”. The CV size can be adjusted.
<b>UDV Name</b>	Name of the UDV.

□ **CV operations description:**

<b>Create</b>	Create a cache volume.
<b>Delete</b>	Delete a cache volume.

If there is no free space for creating a new dedicated cache volume, cut down the global cache size first. After resized, then the dedicated cache volume can be created.

	<p><b>Tips</b></p> <p>The minimum size of global cache volume is <b>40MB</b>. The minimum size of dedicated cache volume is <b>20MB</b>.</p>
---	--

### 3.6.5 Logical unit number

“**Logical unit**” allows users view the status of attached logical unit number of each UDV.

User can attach LUN by clicking the “  ”. “**Host**” must enter an initiator node name for access control, or fill-in wildcard “\*”, which

means every host can access the volume. Choose LUN number and permission, then click “”.

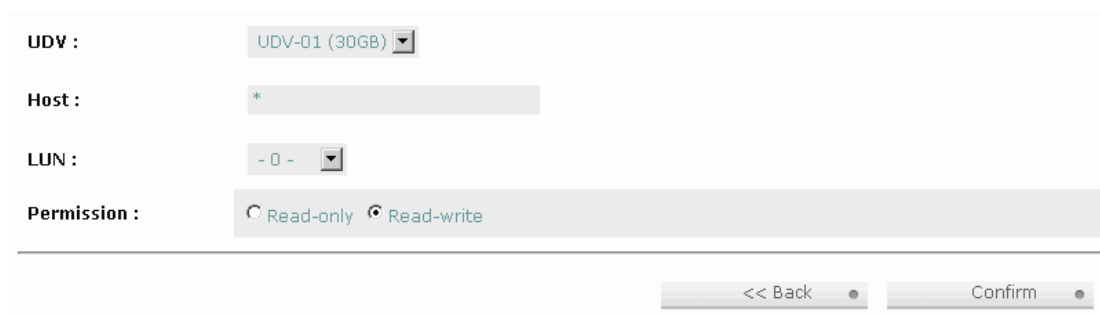

**Figure 3.6.5.1**

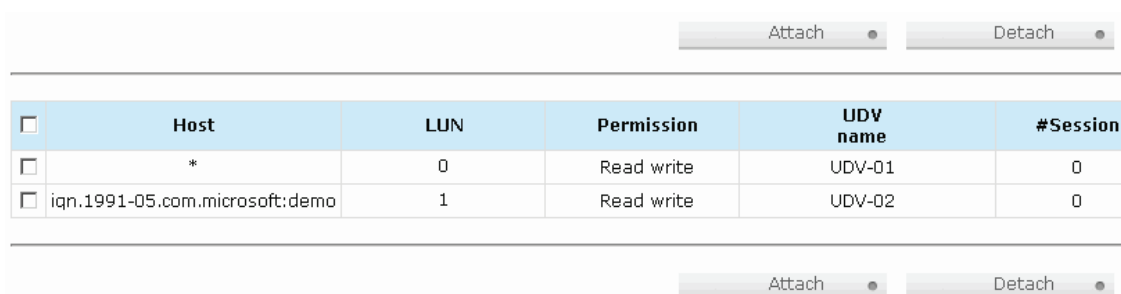

<input type="checkbox"/>	Host	LUN	Permission	UDV name	#Session
<input type="checkbox"/>	*	0	Read write	UDV-01	0
<input type="checkbox"/>	iqn.1991-05.com.microsoft:demo	1	Read write	UDV-02	0

**Figure 3.6.5.2**

(Figure 3.6.5.2: UDV-01 is attached to LUN 0 and every host can access. UDV-02 is attached to LUN 1 and only initiator note named “iqn.1991-05.com.microsoft:demo” can access.)

**LUN operations description:**

<b>Attach</b>	Attach a logical unit number to a user data volume.
<b>Detach</b>	Detach a logical unit number from a user data volume.

The matching rules of access control are inspected from top to bottom in sequence. For example: there are 2 rules for the same UDV, one is “\*”, LUN 0; and the other is “iqn.host1”, LUN 1. The other host “iqn.host2” can login successfully because it matches the rule 1.

The access will be denied when matching rule fails to deploy.

### 3.6.6 Example

The followings are examples of creating volumes. Example 1 is to create two UDV's sharing the same CV (global cache volume) and set a global spare disk. Example 2 is to create two UDV's. One shares the global cache volume, and the other uses dedicated cache volume. Set a dedicated spare disk.

#### □ Example 1

Example 1 is to create two UDV's in one VG, each UDV uses global cache volume. Global cache volume is created after system boots up automatically. So, no action is needed to set CV. Then set a global spare disk. Eventually, delete all of them.

**Step 1:** Create VG (Volume Group).

To create the volume group, please follow the procedures:



The screenshot shows a configuration window for creating a Volume Group (VG). It has three main input sections: 'Name' with the value 'VG-5', 'RAID Level' with a dropdown menu set to 'RAID 5', and 'RAID PD slot' with the value '1 2 3 4'. To the right of the RAID PD slot is a 'Select PD' button. At the bottom of the window are two navigation buttons: '<< Back' and 'Next >>'.

Figure 3.6.6.1

1. Select **"/ Volume config / Volume group"**.
2. Click **" Create "**.
3. Key in a VG Name, choose a RAID level from the list, click **" Select PD "** to choose the RAID PD slot(s), then click **" Next >> "**.
4. Check the outcome. Click **" Confirm "** if all setups are correct.
5. Done. A VG has been created.

											Create	Delete
<input type="checkbox"/>	No.	Name	Total (GB)	Free (GB)	#PD	#UDV	Status	1	2	3	RAID	
<input type="checkbox"/>	1	VG-5	114	114	4	0	Online				RAID 5	

Create      Delete

Figure 3.6.6.2

(Figure 3.6.6.2: Creating a RAID 5 with 4 physical disks, named “VG-R5”. The total size is 114GB. Because there is no related UDV, free size still remains 114GB.)

**Step 2:** Create UDV (User Data Volume).

To create a user data volume, please follow the procedures.

Name : UDV-R5-1

VG name : VG-5

CV No. : Global ( 120 MB )

Capacity (GB) : 50

Stripe height (KB) : 64

Block size (B) : 512

Read/Write :  Write-through cache  Write-back cache

Priority :  High priority  Middle priority  Low priority

<< Back      Confirm

Figure 3.6.6.3

1. Select “/ Volume config / User data volume”.
2. Click “ Create ”.
3. Enter a UDV name, choose a VG Name and enter a size of UDV; decide the stripe high, block size, read/write mode and set priority, then click “ Confirm ”.
4. Done. A UDV has been created.
5. Do one more time to create another UDV.

<div style="text-align: right;"> <span>Attach</span> <span>Create</span> <span>Delete</span> </div>												
<input type="checkbox"/>	No.	Name	Size (GB)	Status	1	2	3	R %	RAID	#LUN	VG name	CV (MB)
<input type="checkbox"/>	1	UDV-R5-1	50	Online	WB	HI	I	4%	RAID 5	0	VG-5	120
<input type="checkbox"/>	2	UDV-R5-2	64	Online	WB	HI	I	0%	RAID 5	0	VG-5	120

Attach Create Delete

Figure 3.6.6.4

(Figure 3.6.6.4: Create UDV's named "UDV-R5-1" and "UDV-R5-2". Regarding to "VG-R5", the size of "UDV-R5-1" is 50GB, the size of "UDV-R5-2" is 64GB. The status of these UDV's are online, write back, high priority with cache volume 120MB. "UDV-R5-1" is initialing about 4%. There is no LUN attached.)

**Step 3: Attach LUN to UDV.**

There are 2 methods to attach LUN to UDV.

1. In **"/ Volume config / User data volume"**, press "Attach".
2. In **"/ Volume config / Logical unit"**, press "Attach".

The procedures are as follows:

UDV :	<input type="text" value="UDV-R5-1 (50GB)"/>
Host :	<input type="text" value="*"/>
LUN :	<input type="text" value="- 0 -"/>
Permission :	<input type="radio"/> Read-only <input checked="" type="radio"/> Read-write

<< Back Confirm

Figure 3.6.6.5

1. Select a UDV.
2. Enter **"Host"** name, which is an initiator node name for access control, or fill-in wildcard **"\*"**, which means every host can access to this volume. Choose LUN and permission, then click



“  ”.

3. Done.

<input type="checkbox"/>	Host	LUN	Permission	UDV name	#Session
<input type="checkbox"/>	*	0	Read write	UDV-R5-1	1 <input type="button" value=""/>
<input type="checkbox"/>	iqn.1991-05.microsoft.com:demo	1	Read write	UDV-R5-2	0

Figure 3.6.6.6

(Figure 3.6.6.6: UDV-R5-1 is attached to LUN 0 and any hosts can access. UDV-R5-2 is attached to LUN 1 and only initiator note named “iqn.1991-05.com.microsoft:demo” can access.)



**Tips**  
The matching rules of access control are from top to bottom in sequence.

**Step 4:** Set global spare disk.

To set global spare disks, please follow the procedures.

1. Select “/ **Volume config / Physical disk**”.
2. Select the free disk(s) by clicking the checkbox in the row, then click “  ” to set as global spares.
3. “**GS**” icon is shown in status 1 column.

<input type="checkbox"/>	Slot	WWN	Size (GB)	VG name	Status	1	2	Speed
<input type="checkbox"/>	1	2007001378a40040	38	VG-R5	Good	RD		1.5Gb
<input type="checkbox"/>	2	2017001378a202d9	38	VG-R5	Good	RD		1.5Gb
<input type="checkbox"/>	3	2018001378a202d9	38	VG-R5	Good	RD		1.5Gb
<input type="checkbox"/>	4	2019001378a202d9	38	VG-R5	Good	RD		1.5Gb
<input type="checkbox"/>	5	201a001378a202d9	38		Good	GS		1.5Gb
<input type="checkbox"/>	6	20c4001378000108	38		Good	FR		1.5Gb
<input type="checkbox"/>	7	201c001378a202d9	38		Good	FR		1.5Gb
<input type="checkbox"/>	8	201b001378a202d9	38		Good	FR		1.5Gb

**Figure 3.6.6.7**

(Figure 3.6.6.7: Slot 5 is set as global spare disk.)

**Step 5:** Done. They can be used as iSCSI disks.

Delete UDV, VG, please follow the steps listed below.

**Step 6:** Detach LUN from UDV.

In “/ Volume config / Logical unit”,

<input checked="" type="checkbox"/>	Host	LUN	Permission	UDV name	#Session
<input checked="" type="checkbox"/>	*	0	Read write	UDV-R5-1	1
<input checked="" type="checkbox"/>	ign.1991-05.microsoft.com:demo	1	Read write	UDV-R5-2	0

**Figure 3.6.6.8**

1. Select LUNs by clicking the checkbox in the row, and then click “”. There will pop up a confirmation page.
2. Choose “OK”.
3. Done.

**Step 7:** Delete UDV (User Data Volume).

To delete the user data volume, please follow the procedures:

1. Select “/ **Volume config / User data volume**”.
2. Select UDVs by clicking the checkbox in the row.
3. Click “  “. There will pop up a confirmation page.
4. Choose “OK”.
5. Done. Then, the UDVs are deleted.



**Tips**

When deleting UDV, the attached LUN(s) related to this UDV will be detached automatically.

**Step 8:** Delete VG (Volume Group).

To delete the volume group, please follow the procedures:

1. Select “/ **Volume config / Volume group**”.
2. Select a VG by clicking the checkbox in the row, make sure there is no UDV on this VG, otherwise the UDV(s) on this VG must be deleted first.
3. Click “  “. There will pop up a confirmation page.
4. Choose “OK”
5. Done. The VG has been deleted.



**Tips**

The action of deleting one VG will succeed only when all of the related UDV(s) are deleted in this VG. Otherwise, it will

**Step 9:** Free global spare disk.

To free global spare disks, please follow the procedures.

1. Select “/ **Volume config / Physical disk**”.
2. Select the global spare disk by clicking the checkbox in the row, then click “ **Free disks** ” to free disk.

**Step 10:** Done, all volumes have been deleted.

#### □ **Example 2**

Example 2 is to create two UDV's in one VG. One UDV shares global cache volume, the other uses dedicated cache volume. First, dedicated cache volume should be created; it can be used in creating UDV. Eventually, delete them.

Each UDV is associated with one specific CV (cache volume) to execute the data transaction. Each CV could have different cache memory size. If there is no special request in UDV's, it uses global cache volume. Or user can create a dedicated cache for individual UDV manually. Using dedicated cache volume, the performance would not be affected by other UDV's data access.

The total cache size depends on the RAM size and then set all cache size as global cache automatically. To create a dedicated cache volume, first step is to cut down global cache size for the dedicated cache volume. Please follow the procedures.



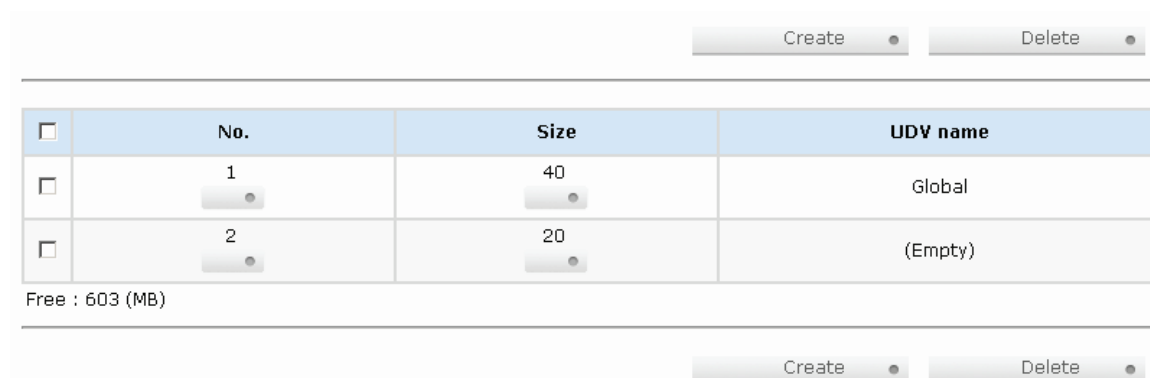

**Step 1:** Create dedicated cache volume.



<input type="checkbox"/>	No.	Size	UDV name
<input type="checkbox"/>	1	40	Global
<input type="checkbox"/>	2	20	(Empty)

Free : 603 (MB)

**Figure 3.6.6.9**

1. Select “/ **Volume config / Cache volume**”.
2. If there is no free space for creating a new dedicated cache volume. Firstly, decrease the global cache size by clicking the button “” in size column. After resizing, click “” to return to the cache volume page.
3. Click “” to enter the setup page.
4. Fill in the size and click “”.
5. Done. A new dedicated cache volume has been set.



**Tips**  
 The minimum size of global cache volume is **40MB**. The minimum size of dedicated cache volume is **20MB**.



**Step 2:** Create VG (Volume Group).

Please refer to Step 1 of Example 1 to create VG.

**Step 3:** Create UDV (User Data Volume).

Please refer to Step 2 of Example 1 to create UDV. To create a UDV with dedicated cache volume, please follow the below procedures.

<b>Name :</b>	UDV-R5-2
<b>VG name :</b>	VG-5 ▾
<b>CV No. :</b>	Dedicated ( 20 MB ) ▾
<b>Capacity (GB) :</b>	64
<b>Stripe height (KB) :</b>	64 ▾
<b>Block size (B) :</b>	512 ▾
<b>Read/Write :</b>	<input type="radio"/> Write-through cache <input checked="" type="radio"/> Write-back cache
<b>Priority :</b>	<input checked="" type="radio"/> High priority <input type="radio"/> Middle priority <input type="radio"/> Low priority

**Figure 3.6.6.10**

1. Select “/ **Volume config / User data volume**”.
2. Click “”.

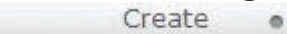
- Enter a UDV name, choose a VG Name, and select **“Dedicated”** cache which is created at Step 1. Enter the size of UDV; decide the stripe height, block size, read/write mode and set priority, then click **“Confirm”**.
- Done. A UDV using dedicated cache has been created.

<input type="checkbox"/>	No.	Name	Size (GB)	Status	1	2	3	R %	RAID	#LUN	VG name	CV (MB)
<input type="checkbox"/>	1	UDV-R5-1	50	Online	f WB	f HI			RAID 5	1	VG-5	40
<input type="checkbox"/>	2	UDV-R5-2	64	Online	f WB	f HI	5%	5%	RAID 5	0	VG-5	20

Figure 3.6.6.11

(Figure 3.6.6.11: UDV named “UDV-R5-1” uses global cache volume 40MB, and “UDV-R5-2” uses dedicated cache volume 20MB. “UDV-R5-2” is initialing about 5%.)

<input type="checkbox"/>	No.	Size	UDV name
<input type="checkbox"/>	1	40	Global
<input type="checkbox"/>	2	20	UDV-R5-2

Free : 603 (MB)

Figure 3.6.6.12

(Figure 3.6.6.12: In “/ Volume config / Cache volume”, UDV named “UDV-R5-2” uses dedicated cache volume 20MB.)

**Step 4:** Attach LUN to UDV.

Please refer to Step 3 of Example 1 to attach LUN.

**Step 5:** Set dedicated spare disk.

To set dedicated spare disks, please follow the procedures:

1. Select “/ **Volume config / Physical disk**”.
2. Select a VG from the list, then select the free disk(s). Click “ **Dedicated spares** ” to set the dedicated spare for the VG.
3. The “**DS**” icon is shown in the column of status 1.

<span style="float: left;">- Select - ▾</span> <span style="margin-left: 50px;">Free disks ●</span> <span style="margin-left: 50px;">Global spares ●</span> <span style="margin-left: 50px;">Dedicated spares ●</span>								
<input type="checkbox"/>	Slot	WWN	Size (GB)	VG name	Status	1	2	Speed
<input type="checkbox"/>	1	2007001378a40040	38	VG-R5	Good	RD		1.5Gb
<input type="checkbox"/>	2	2017001378a202d9	38	VG-R5	Good	RD		1.5Gb
<input type="checkbox"/>	3	2018001378a202d9	38	VG-R5	Good	RD		1.5Gb
<input type="checkbox"/>	4	2019001378a202d9	38	VG-R5	Good	RD		1.5Gb
<input type="checkbox"/>	5	201a001378a202d9	38	VG-R5	Good	DS		1.5Gb
<input type="checkbox"/>	6	20c4001378000108	38		Good	FR		1.5Gb
<input type="checkbox"/>	7	201c001378a202d9	38		Good	FR		1.5Gb
<input type="checkbox"/>	8	201b001378a202d9	38		Good	FR		1.5Gb

Figure 3.6.6.13

(Figure 3.6.6.13: Slot 5 has been set as dedicated spare disk of VG named “VG-R5”.)

**Step 6:** Done. The PDs can be used as iSCSI disks.

Delete UDV and VG, please follow the steps.

**Step 7:** Detach LUN from UDV.

Please refer to Step 6 of Example 1 to detach LUN.

**Step 8:** Delete UDV (User Data Volume).

Please refer to Step 7 of Example 1 to delete UDV.

**Step 9:** Delete VG (User Data Volume).

Please refer to Step 8 of Example 1 to delete VG.

**Step 10:** Free dedicated spare disk.

To free dedicated spare disks, please follow the procedures:

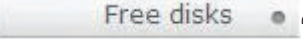
1. Select “/ **Volume config / Physical disk**”.
2. Select the dedicated spare disk by clicking the checkbox in the row, then click “  “ to free disk.

**Step 11:** Delete dedicated cache volume.

To delete the cache volume, please follow the procedures:

1. Select “/ **Volume config / Cache volume**”.
2. Select a CV by clicking the checkbox in the row.
3. Click “  “. There will pop up a confirmation page.
4. Choose “OK”.
5. Done. The CV has been deleted.

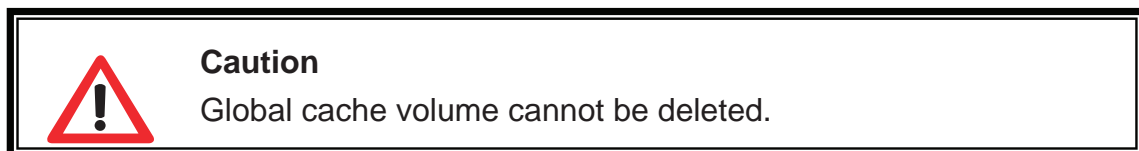

**Step 12:** Done, all volumes have been deleted.

## 3.7 Enclosure management

“**Enclosure management**” allows managing enclosure information including “**SES config**”, “**Hardware monitor**”, “**S.M.A.R.T.**” and “**UPS**”. For the enclosure management, there are many sensors for different purposes, such as temperature sensors, voltage sensors, hard disks, fan sensors, power sensors, and LED status. Due to the different hardware characteristics among these sensors, they have different polling intervals. Below is the detail polling



time intervals:

1. Temperature sensors: 1 minute.
2. Voltage sensors: 1 minute.
3. Hard disk sensors: 10 minutes.
4. Fan sensors: 10 seconds . When there are 3 errors consecutively, controller sends ERROR event log.
5. Power sensors: 10 seconds, when there are 3 errors consecutively, controller sends ERROR event log.
6. LED status: 10 seconds.

<b>SES config</b>	Access control for SES management	<b>SES config</b>	Access control for SES management
<b>Hardware monitor</b>	System monitor for voltage, temperature and battery backup module	<b>Hardware monitor</b>	System monitor for voltage, temperature and battery backup module
<b>S.M.A.R.T.</b>	Self-monitoring analysis and reporting technology for physical disks	<b>S.M.A.R.T.</b>	Self-monitoring analysis and reporting technology for physical disks
<b>LED</b>	Writeable power supply	<b>LED</b>	Writeable power supply

Figure 3.7.1

### 3.7.1 SES configuration

**SES** represents **SCSI Enclosure Services**, one of the enclosure management standards. “**SES config**” can enable or disable the management of SES.

				Enable ●	Disable ●
<input type="checkbox"/>	Host	LUN	Permission	UDV name	
<input type="checkbox"/>	*	0	Read write	(SES)	
				Enable ●	Disable ●

Figure 3.7.1.1

(Figure 3.7.1.1: Enable SES in LUN 0, and can be accessed from every host.)

The SES client software is available at the following web site:

SANtools: <http://www.santools.com/>

### 3.7.2 Hardware monitor

“**Hardware monitor**” allows users view the information of current voltage and temperature.

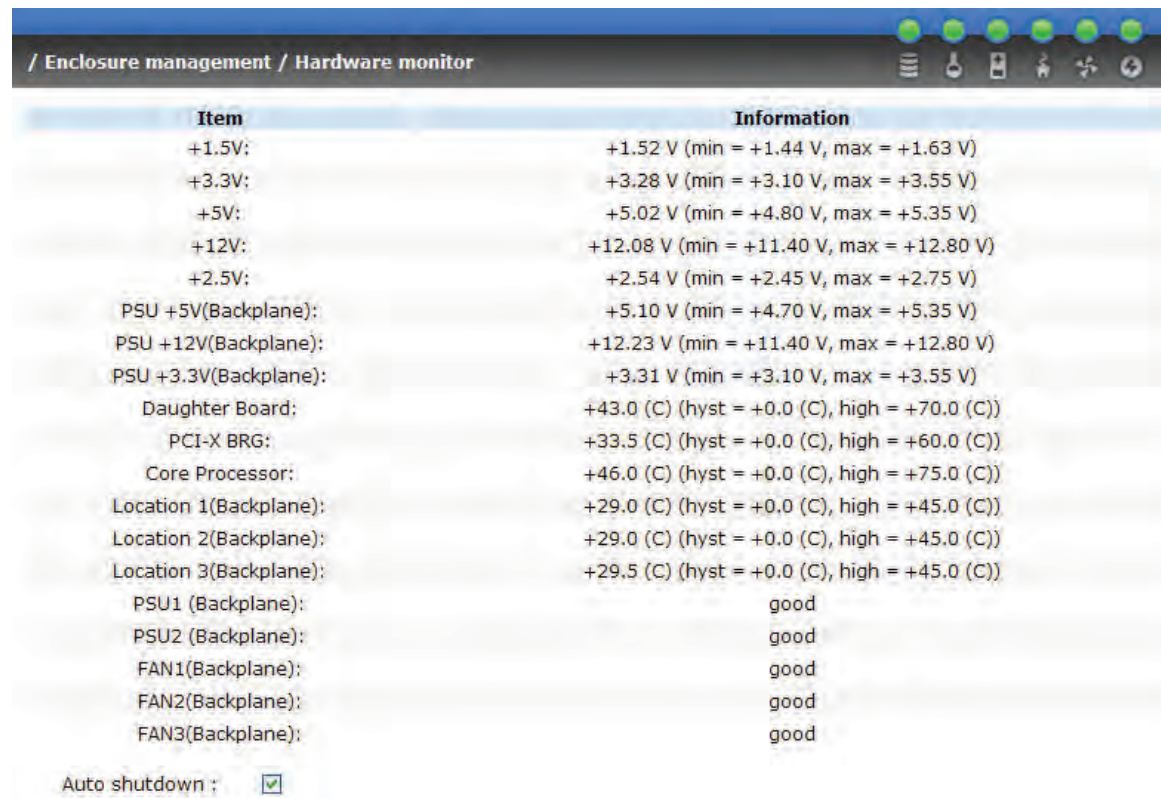

The screenshot shows a web interface for hardware monitoring. The title bar reads "/ Enclosure management / Hardware monitor". Below the title bar is a table with two columns: "Item" and "Information". The table lists various hardware components and their current status, including voltage levels and temperatures. At the bottom of the table, there is a checkbox labeled "Auto shutdown" which is checked.

Item	Information
+1.5V:	+1.52 V (min = +1.44 V, max = +1.63 V)
+3.3V:	+3.28 V (min = +3.10 V, max = +3.55 V)
+5V:	+5.02 V (min = +4.80 V, max = +5.35 V)
+12V:	+12.08 V (min = +11.40 V, max = +12.80 V)
+2.5V:	+2.54 V (min = +2.45 V, max = +2.75 V)
PSU +5V(Backplane):	+5.10 V (min = +4.70 V, max = +5.35 V)
PSU +12V(Backplane):	+12.23 V (min = +11.40 V, max = +12.80 V)
PSU +3.3V(Backplane):	+3.31 V (min = +3.10 V, max = +3.55 V)
Daughter Board:	+43.0 (C) (hyst = +0.0 (C), high = +70.0 (C))
PCI-X BRG:	+33.5 (C) (hyst = +0.0 (C), high = +60.0 (C))
Core Processor:	+46.0 (C) (hyst = +0.0 (C), high = +75.0 (C))
Location 1(Backplane):	+29.0 (C) (hyst = +0.0 (C), high = +45.0 (C))
Location 2(Backplane):	+29.0 (C) (hyst = +0.0 (C), high = +45.0 (C))
Location 3(Backplane):	+29.5 (C) (hyst = +0.0 (C), high = +45.0 (C))
PSU1 (Backplane):	good
PSU2 (Backplane):	good
FAN1(Backplane):	good
FAN2(Backplane):	good
FAN3(Backplane):	good

Auto shutdown :

Figure 3.7.2.1

If “**Auto shutdown**” has been detected, the system will shutdown automatically when voltage or temperature is out of the normal range. For better data protection, please check “**Auto Shutdown**”.

For better protection and avoiding single short period of high temperature or alias triggering auto shutdown, controllers use multiple condition judgments for auto shutdown, below are the details of condition that Auto shutdown will be triggered.

1. There are 3 sensors placed on controllers for temperature checking, they are on core processor, PCI-X bridge, and daughter board. controller will check each sensor every 30 seconds. When one of these sensors is over high temperature value for continuously 3 minutes, auto shutdown will be triggered immediately.

2. The core processor temperature limit is 85°C . The PCI-X bridge temperature limit is 80°C . The daughter board temperature limit is 80°C .
3. If the overheat situation doesn't last for 3 minutes, controller will not do auto shutdown.

### **3.7.3 Hard drive S.M.A.R.T. support**

**S.M.A.R.T.** (**S**elf-**M**onitoring **A**nalysis and **R**eporting **T**echnology) is a diagnostic tool for hard drives to deliver warning of drive failures in advance. S.M.A.R.T. provides users chances to take actions before possible drive failure.

S.M.A.R.T. measures many attributes of the hard drive all the time and inspects the properties of hard drives which are close to be intolerable. The advanced notice of possible hard drive failure can allow users to back up hard drive or replace the hard drive. This is much better than hard drive crash when it is writing data or rebuilding a failed hard drive.

“**S.M.A.R.T.**” allows users display S.M.A.R.T. information of hard drives. The number is the current value; the number in parenthesis is the threshold value. The threshold values of hard drive vendors are different; please refer to vendors' specification for details.

S.M.A.R.T. only supports SATA drive. SAS drive does not have. It will show N/A in this web page.

Slot	Read error rate	Spin up time	Reallocated sector count	Seek error rate	Spin up retries	Calibration retries	Temperature (C)	Status
1		203(63)	253(63)	253(0)	253(157)	253(223)	41	Good
2	100(16)	107(24)	100(5)	100(67)	100(60)		31	Good
3	100(16)	104(24)	100(5)	100(67)	100(60)		32	Good
4	70(6)	96(0)	100(36)	75(30)	100(97)		31	Good
5	100(16)	102(24)	100(5)	100(67)	100(60)		32	Good
6		203(63)	253(63)	253(0)	253(157)	253(223)	28	Good
7	94(16)	99(24)	100(5)	100(67)	100(60)		31	Good
8	200(51)	171(21)	200(140)	200(51)	100(51)	100(51)	30	Good

Figure 3.7.3.1

### 3.8 System maintenance

“**Maintenance**” allows operation of the system functions including “**Upgrade**” to the latest firmware, “**Info**” to show the system version, “**Reset to default**” to reset all controller configuration values to factory settings, “**Config import & export**” to import and export all controller configuration except VG/UDV setting and LUN setting, and “**Shutdown**” to either reboot or shutdown the system.

<u>Upgrade</u>	Remote upload firmware	<u>Upgrade</u>	Remote upload firmware
<u>Reset to default</u>	Reset to factory default	<u>Reset to default</u>	Reset to factory default
<u>Shutdown</u>	Reboot or shutdown system	<u>Shutdown</u>	Reboot or shutdown system

Figure 3.8.1

### 3.8.1 Upgrade

“Upgrade” allows users upgrade firmware. Please prepare new firmware file named “xxxx.bin” in local hard drive, then click “[Browse...](#) [Browse...](#)” to select the file. Click “[Confirm](#)”, it will pop up a message “Upgrade system now? If you want to downgrade to the previous FW later (not recommend), please export your system configuration in advance”, click “**Cancel**” to export system configuration in advance, then click “**OK**” to start to upgrade firmware.



Figure 3.8.1.1

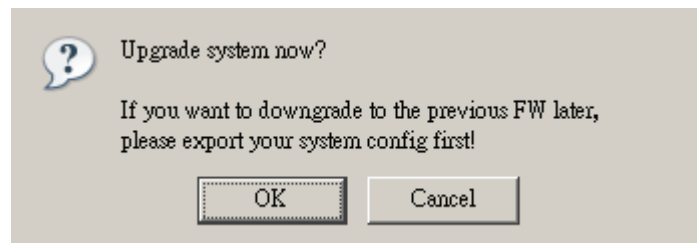



Figure 3.8.1.2

When upgrading, there is a progress bar running. After finished upgrading, the system must reboot manually to make the new firmware took effect.



**Tips**  
Please contact with [tech@istarusa.com](mailto:tech@istarusa.com) for latest firmware.

### 3.8.2 Info

“Info” can display system information (including firmware version), CPU type, installed system memory, and controller serial number.

### 3.8.3 Reset to default

“Reset to default” allows user to reset controller to the factory default setting.



Figure 3.8.3.1

Reset to default value, the password is: **1234**, and IP address to default DHCP.

Default IP address: **192.168.10.50** (DHCP)

Default subnet mask: **255.255.255.0**

Default gateway: **192.168.10.254**

### 3.8.4 Config import & export

“Config import & export” allows user to save system configuration values: export, and apply all configuration: import. For the volume configuration setting, the values are available in export and not available in import which can avoid conflict/delete between two controllers. That says if one controller already exists valuable data in the disks and user may forget to overwrite it. Use import could return to original configuration. If the volume setting was also imported, user’s current data will be overwritten.

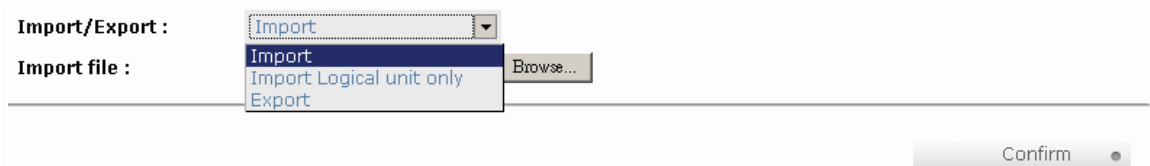



Figure 3.8.4.1

1. **Import:** Import all system configurations excluding volume config.
2. **Import Logical unit only:** No system nor volume configurations, import LUN configurations only.
3. **Export:** Export all configurations to a file.

	<p><b>Caution</b> “<b>Import</b>” will import all system configurations excluding volume configuration; the current configurations will be</p>
---	--

### 3.8.5 Shutdown

“**Shutdown**” displays “**Reboot**” and “**Shutdown**” buttons. Before power off, it’s better to execute “**Shutdown**” to flush the data from cache to physical disks. The step is necessary for data protection.



Figure 3.8.5.1

## 3.9 Logout

For security reason, “**Logout**” allows users logout when no user is operating the system. Re-login the system; please enter username and password again.

# Chapter 4 Advanced operation

## 4.1 Rebuild

If one physical disk of the VG which is set as protected RAID level (e.g.: RAID 3, RAID 5, or RAID 6) is FAILED or has been unplugged/removed, then the status of VG is changed to degraded mode, the system will search/detect spare disk to rebuild the degraded VG to a complete one. It will detect dedicated spare disk as rebuild disk first, then global spare disk.

**iStarUSA iSCSI series** controllers support Auto-Rebuild. The following is the scenario:

Take RAID 6 for example:

1. When there is no global spare disk or dedicated spare disk in the system, controller will be in degraded mode and wait until (A) there is one disk assigned as spare disk, or (B) the failed disk is removed and replaced with new clean disk, then the Auto-Rebuild starts. The new disk will be a spare disk to the original VG automatically.

If the new added disk is not clean (with other VG information), it would be marked as RS (reserved) and the system will not start "auto-rebuild".

If this disk is not belonging to any existing VG, it would be FR (Free) disk and the system will start Auto-Rebuild.

If user only removes the failed disk and plugs the same failed disk in the same slot again, the auto-rebuild will start running. But rebuilding in the same failed disk may impact customer data if the status of disk is unstable. **iStarUSA** suggests all customers not to rebuild in the failed disk for better data protection.

2. When there is enough global spare disk(s) or dedicated spare disk(s) for the degraded array, controller starts Auto-Rebuild immediately. Moreover, in RAID 6, if there is another disk failure occurs during



rebuilding, controller will start the above Auto-Rebuild process as well. Auto-Rebuild feature only works at that the status of VG is "**Online**". It will not work at "**Offline**". Thus, it will not conflict with the "**Roaming**".

3. In degraded mode, the status of VG is "Degraded". When rebuilding, the status of VG/UDV will be "Rebuild", the column "R%" in UDV will display the ratio in percentage. After complete rebuilding, the status will become "Online". VG will become completely one.

	<p><b>Tips</b></p> <p>"<b>Set dedicated spare</b>" is not available if there is no VG or only VG of RAID 0, JBOD, because user can not set dedicated</p>
---	--





Sometimes, rebuild is called recover; they are the same meaning. The following table is the relationship between RAID levels and rebuild.

<b>RAID 0</b>	Disk striping. No protection for data. VG fails if any hard drive fails or unplugs.
<b>RAID 1</b>	Disk mirroring over 2 disks. RAID 1 allows one hard drive fails or unplugging. Need one new hard drive to insert to the system and rebuild to be completed.
<b>N-way mirror</b>	Extension to RAID 1 level. It has N copies of the disk. N-way mirror allows N-1 hard drives failure or unplugging.
<b>RAID 3</b>	Striping with parity on the dedicated disk. RAID 3 allows one hard drive failure or unplugging.
<b>RAID 5</b>	Striping with interspersed parity over the member disks. RAID 5 allows one hard drive failure or unplugging.
<b>RAID 6</b>	2-dimensional parity protection over the member disks. RAID

	6 allows two hard drives failure or unplugging. If it needs to rebuild two hard drives at the same time, it will rebuild the first one, then the other in sequence.
<b>RAID 0+1</b>	Mirroring of RAID 0 volumes. RAID 0+1 allows two hard drive failures or unplugging, but at the same array.
<b>RAID 10</b>	Striping over the member of RAID 1 volumes. RAID 10 allows two hard drive failure or unplugging, but in different arrays.
<b>RAID 30</b>	Striping over the member of RAID 3 volumes. RAID 30 allows two hard drive failure or unplugging, but in different arrays.
<b>RAID 50</b>	Striping over the member of RAID 5 volumes. RAID 50 allows two hard drive failures or unplugging, but in different arrays.
<b>RAID 60</b>	Striping over the member of RAID 6 volumes. RAID 40 allows four hard drive failures or unplugging, every two in different arrays.
<b>JBOD</b>	The abbreviation of “ <b>J</b> ust a <b>B</b> unch <b>O</b> f <b>D</b> isks”. No data protection. VG fails if any hard drive failures or unplugs.

## 4.2 VG migration and expansion

To migrate the RAID level, please follow below procedures.

1. Select “/ **V**olume **c**onfig / **V**olume **g**roup”.
2. Decide VG to be migrated, click the button “” in the RAID column next the RAID level.
3. Change the RAID level by clicking the down arrow “”. There will be a pup-up which shows if the HDD is not enough to support the new setting of RAID level, click “” to increase hard drives, then click “” to go back to setup page. When doing migration to lower RAID level, such as

the original RAID level is RAID 6 and user wants to migrate to RAID 0, the controller will evaluate whether this operation is safe or not, and appear a message of **"Sure to migrate to a lower protection array?"** to give user warning.

4. Double check the setting of RAID level and RAID PD slot. If there is no problem, click "".
5. Finally a confirmation page shows the detail of RAID info. If there is no problem, click "". Controller also pops up a message of **"Warning: power lost during migration may cause damage of data!"** to give user warning. When the power is abnormally off during the migration, the data is in high risk.
1. Migration starts and it can be seen from the "status 3" of a VG with a running square and an "M". In **"/ Volume config / User data volume"**, it displays an "M" in **"Status 4"** and complete percentage of migration in **"R%"**.

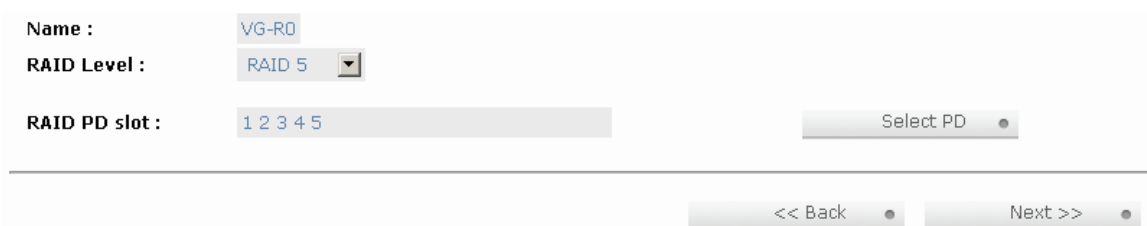

Figure 4.2.1

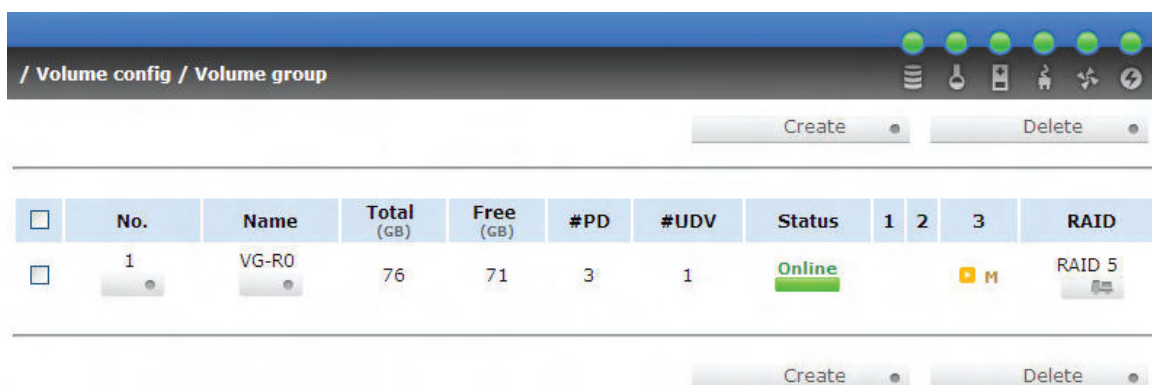

Figure 4.2.2

(Figure 4.2.2: A RAID 0 with 2 physical disks migrates to RAID 5 with 3 physical disks.)

/ Volume config / User data volume

Attach • Snapshot • Create • Delete •

<input type="checkbox"/>	No.	Name	Size (GB)	Status	1	2	3	R %	RAID	#LUN	Snapshot (GB)	VG name	CV (MB)
<input type="checkbox"/>	1	UDV-R0	5	Online				12%	RAID 5	0	0.00/0.00	VG-R0	100

Attach • Snapshot • Create • Delete •

Figure 4.2.3

(Figure 4.2.3: A RAID 0 migrates to RAID 5, the complete percentage is 12%.)

To do migration, the total size of VG must be larger or equal to the original VG. It does not allow expanding the same RAID level with the same hard disks of original VG.

During the setting migration, if user doesn't setup correctly, controller will pop up warning messages. Below is the detail of messages.



1. **Invalid VG ID:** Source VG is invalid.
2. **Degrade VG not allowed:** Source VG is degraded.
3. **Initializing/rebuilding operation's going:** Source VG is initializing or rebuilding.
4. **Migration operation's going:** Source VG is already in migration.
5. **Invalid VG raidcell parameter:** Invalid configuration. E.g., New VG's capacity < Old VG's capacity, New VG's stripe size < Old VG's stripe size. Or New VG's configuration == Old VG's configuration.
6. **Invalid PD capacity:** New VG's minimum PD capacity < Old VG's minimum PD capacity.



**Caution**  
VG Migration cannot be executed during rebuild or UDV extension.

## 4.3 UDV Extension

To extend UDV size, please follow the procedures.

1. Select “/ Volume config / User data volume”.
2. Decide which UDV to extend, click the button “” in the Size column next the number.
3. Change the size. The size must be larger than the original, and then click “ Confirm ” to start extension.
4. Extension starts. If UDV needs initialization, it will display an “I” in “Status 3” and complete percentage of initialization in “R%”.

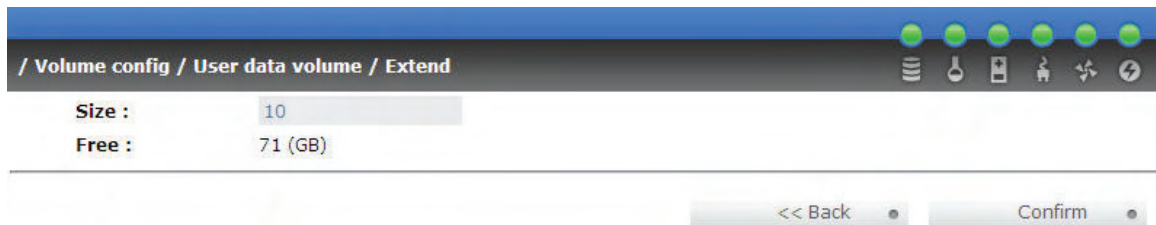

Figure 4.3.1

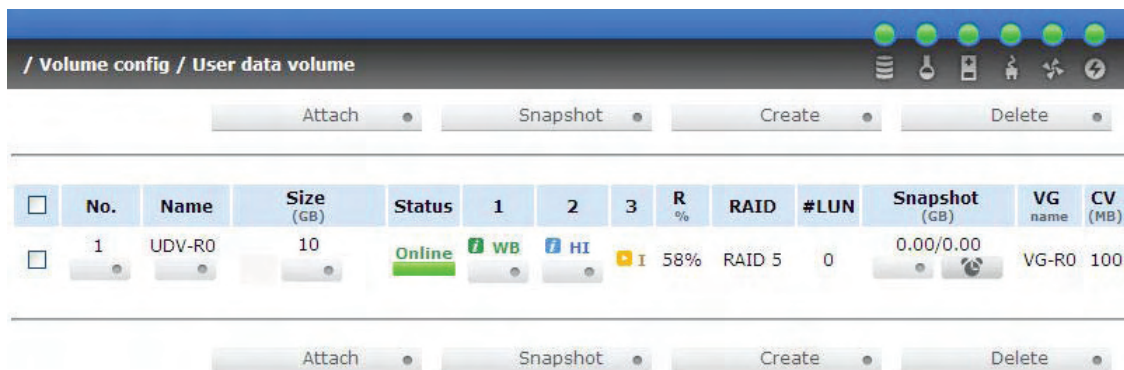

Figure 4.3.2

(Figure 4.3.2: Extend UDV-R0 from 5GB to 10GB.)



### Tips

The size of UDV extension must be larger than original.



### **Caution**

UDV Extension cannot be executed during rebuild or migration.

## **4.4 Disk roaming**

Physical disks can be re-sequenced in the same system or move all physical disks from system-1 to system-2. This is called disk roaming. Disk roaming has some constraints as described in the followings:

1. Check the firmware of two systems first. It is better that both systems have the same firmware version or newer.
2. All physical disks of related VG should be moved from system-1 to system-2 together. The configuration of both VG and UDV will be kept but LUN configuration will be cleared in order to avoid conflict with system-2.

## **4.5 Support Microsoft MPIO and MC/S**

**MPIO** (Multi-Path Input/Output) and **MC/S** (Multiple Connections per Session) use multiple physical paths to create logical "paths" between the server and the storage device. In this case, which one or more of these components fails, causing the path to fail, multi-path logic uses an alternate path for I/O. So applications can still access their data.

Microsoft iSCSI initiator supports multi-path. Please follow the procedures to use MPIO feature.

1. A host with dual LAN ports connects cables to controller.
2. Create a VG/UDV and attach this UDV to the host.
3. When installing "**Microsoft iSCSI initiator**", please install MPIO

driver at the same time.

4. Logon to target separately on each port. When logon to target, check "**Enable multi-path**".
5. MPIO mode can be selected on Targets → Details → Devices → Advanced in Microsoft iSCSI initiator.
6. Rescan disk.
7. There will be one disk running MPIO.

# Appendix

## A. Certification list

### □ RAM

**iStarUSA iSCSI Series RAM Spec:** 184pins, DDR333(PC2700), Reg.(register) or UB(Unbuffered), ECC or Non-ECC, from 64MB to 1GB, 32-bit or 64-bit data bus width, x8 or x16 devices, 9 to 11 bits column address.

Vendor	Model
ATP	AG64L72T8SQC4S, 512MB DDR-400 (ECC) with Samsung
ATP	AG28L64T8SHC4S, 1GB DDR-400 with Samsung
ATP	AG28L72T8SHC4S, 1GB DDR-400 (ECC) with Samsung
ATP	AB28L72Q8SHC4S, 1GB DDR-400 (ECC, Reg.) with Samsung
Unigen	UG732D6688KN-DH, 256MB DDR-333 (Unbuffered) with Hynix
Unigen	UG732D7588KZ-DH, 256MB DDR-333 (ECC, Reg.) with Elpida
Unigen	UG764D7588KZ-DH, 512MB DDR-333 (ECC, Reg.) with Elpida
Unigen	UG7128D7588LZ-DH, 1GB DDR-333 (ECC, Reg.) with Hynix
Unigen	UG7128D7488LN-GJF, 1GB DDR-400 (ECC) with Hynix
Unigen	UG7128D7588LZ-GJF, 1GB DDR-400 (ECC, Reg.) with Hynix
Unigen	UG7128D7588LZ-GJF, 1GB DDR-400 (ECC, Reg.) with Elpida
Unigen	UG732D6688KS-DH, 256MB DDR-333 (Unbuffered, Low profile) with Hynix
Unigen	UG764D6688LS-DH, 512MB DDR-333 (Unbuffered, Low profile) with Hynix
Unigen	UG718D6688LN-GJF, 1GB DDR-400 with Hynix
Unigen	UG718D6688LN-GJF, 1GB DDR-400 with Elpida

### □ iSCSI Initiator (Software)

OS	Software/Release Number
Microsoft Windows	Microsoft iSCSI Software Initiator Release v2.07  System Requirements: <ol style="list-style-type: none"> <li>1. Windows 2000 Server with SP4</li> <li>2. Windows Server 2003 with SP2</li> <li>3. Windows Server 2003 R2 with SP2</li> <li>4. Windows Server 2008</li> </ol>
Linux	The iSCSI Initiators are different for different Linux Kernels.  <ol style="list-style-type: none"> <li>1. For Red Hat Enterprise Linux 3 (Kernel 2.4), install linux-iscsi-3.6.3.tar</li> </ol>



	<ol style="list-style-type: none"> <li>2. For Red Hat Enterprise Linux 4 (Kernel 2.6), use the build-in iSCSI initiator iscsi-initiator-utils-4.0.3.0-4 in kernel 2.6.9</li> <li>3. For Red Hat Enterprise Linux 5 (Kernel 2.6), use the build-in iSCSI initiator iscsi-initiator-utils-6.2.0.742-0.5.el5 in kernel 2.6.18</li> </ol>
Mac	ATTO Xtend SAN iSCSI initiator v3.10  System Requirements: <ol style="list-style-type: none"> <li>1. Mac OS X v10.5 or later</li> </ol>

For ATTO Xtend SAN iSCSI initiator, it is not free. Please contact your local distributor.

□ **iSCSI HBA card**

Vendor	Model
HP	NC380T (PCI-Express, Gigabit, 2 ports, TCP/IP offload, iSCSI offload)
QLogic	QLA4010C (PCI-X, Gigabit, 1 port, TCP/IP offload, iSCSI offload)
QLogic	QLA4052C (PCI-X, Gigabit, 2 ports, TCP/IP offload, iSCSI offload)

□ **NIC**

Vendor	Model
HP	NC7170 (PCI-X, Gigabit, 2 ports)
HP	NC360T (PCI-Express, Gigabit, 2 ports, TCP/IP offload)
IBM	NetXtreme 1000 T (73P4201) (PCI-X, Gigabit, 2 ports, TCP/IP offload)
Intel	PWLA8492MT (PCI-X, Gigabit, 2 ports, TCP/IP offload)

□ **GbE Switch**

Vendor	Model
Dell	PowerConnect 5324
Dell	PowerConnect 2724
Dell	PowerConnect 2708
HP	ProCurve 1800-24G

□ **Hard drive**

**iStarUSA iSCSI Series** support SATA I, II disks.

Vendor	Model
Hitachi	Deskstar 7K250, HDS722580VLSA80, 80GB, 7200RPM, SATA, 8M
Hitachi	Deskstar E7K500, HDS725050KLA360, 500GB, 7200RPM, SATA II, 16M
Hitachi	Deskstar 7K80, HDS728040PLA320, 40GB, 7200RPM, SATA II, 2M
Hitachi	Deskstar T7K500, HDT725032VLA360, 320GB, 7200RPM, SATA II, 16M

Hitachi	Deskstar P7K500, HDP725050GLA360, 500GB, 7200RPM, SATA II, 16M
Maxtor	DiamondMax Plus 9, 6Y080M0, 80GB, 7200RPM, SATA, 8M
Maxtor	DiamondMax 11, 6H500F0, 500GB, 7200RPM, SATA 3.0Gb/s, 16M
Samsung	SpinPoint P80, HDSASP0812C, 80GB · 7200RPM, SATA, 8M
Seagate	Barracuda 7200.7, ST380013AS, 80GB, 7200RPM, SATA 1.5Gb/s, 8M
Seagate	Barracuda 7200.7, ST380817AS, 80GB, 7200RPM, SATA 1.5Gb/s, 8M, NCQ
Seagate	Barracuda 7200.8, ST3400832AS, 400GB, 7200RPM, SATA 1.5Gb/s, 8M, NCQ
Seagate	Barracuda 7200.9, ST3500641AS, 500GB, 7200RPM, SATA 3.0Gb/s, 16M, NCQ
Seagate	Barracuda 7200.11, ST31000340AS, 1000GB, 7200RPM, SATA 3.0Gb/s, 32M, NCQ
Seagate	NL35, ST3400633NS, 400GB, 7200RPM, SATA 3.0Gb/s, 16M
Seagate	NL35, ST3500641NS, 500GB, 7200RPM, SATA 3.0Gb/s, 16M
Seagate	Barracuda ES, ST3500630NS, 500GB, 7200RPM, SATA 3.0Gb/s, 16M
Seagate	Barracuda ES, ST3750640NS, 750GB, 7200RPM, SATA 3.0Gb/s, 16M
Seagate	Barracuda ES.2, ST31000340NS, 1000GB, 7200RPM, SATA 3.0Gb/s, 32M
Western Digital	Caviar SE, WD800JD, 80GB, 7200RPM, SATA 3.0Gb/s, 8M
Western Digital	Caviar SE, WD1600JD, 160GB, 7200RPM, SATA 1.5G/s, 8M
Western Digital	Raptor, WD360GD, 36.7GB, 10000RPM, SATA 1.5Gb/s, 8M
Western Digital	Caviar RE2, WD4000YR, 400GB, 7200RPM, SATA 1.5Gb/s, 16M, NCQ
Western Digital	RE2, WD4000YS, 400GB, 7200RPM, SATA 3.0Gb/s, 16M
Western Digital	Caviar RE16, WD5000AAKS, 500GB, 7200RPM, SATA 3.0Gb/s, 16M
Western Digital	RE2, WD5000ABYS, 500GB, 7200RPM, SATA 3.0Gb/s, 16M, NCQ

## B. Event notifications

### □ PD events

Level	Type	Description
<b>INFO</b>	Disk inserted	Disk <slot> is inserted into system.
<b>WARNING</b>	Disk removed	Disk <slot> is removed from system.
<b>ERROR</b>	HDD failure	Disk <slot> is disabled.

### □ HW events

Level	Type	Description
<b>WARNING</b>	ECC error	Single-bit ECC error is detected.
<b>ERROR</b>	ECC error	Multi-bit ECC error is detected.

<b>INFO</b>	ECC info	ECC memory is installed.
<b>INFO</b>	ECC info	Non-ECC memory is installed.
<b>INFO</b>	SCSI info	Received SCSI Bus Reset event at the SCSI Bus <number>.

□ **EMS events**

<b>Level</b>	<b>Type</b>	<b>Description</b>
<b>INFO</b>	Power installed	Power <number> is installed.
<b>ERROR</b>	Power absent	Power <number> is absent.
<b>INFO</b>	Power work	Power <number> is restored to work.
<b>ERROR</b>	Power warning	Power <number> is out of work.
<b>WARNING</b>	Power detect	PSU signal detection <number>.
<b>INFO</b>	Fan work	Fan <number> is restored to work.
<b>ERROR</b>	Fan warning	Fan <number> is out of work.
<b>INFO</b>	Fan installed	Fan <number> is installed.
<b>ERROR</b>	Fan not present	Fan <number> is not present.
<b>WARNING</b>	Thermal warning	System temperature <location> is a little bit higher.
<b>ERROR</b>	Thermal critical	System Overheated <location>!!!
<b>ERROR</b>	Thermal critical shutdown	System Overheated <location>!!! The system will do the auto shutdown immediately.
<b>WARNING</b>	Thermal ignore value	Unable to update thermal value on <location>.
<b>WARNING</b>	Voltage warning	System voltage <location> is a little bit higher/lower.
<b>ERROR</b>	Voltage critical	System voltages <location> failed!!!
<b>ERROR</b>	Voltage critical shutdown	System voltages <location> failed!!! The system will do the auto shutdown immediately.
<b>INFO</b>	UPS info	UPS detection succeeded.
<b>WARNING</b>	UPS error	UPS detection failed.
<b>ERROR</b>	UPS error	AC loss for the system is detected.
<b>ERROR</b>	UPS error	UPS Power Low!!! The system will do the auto shutdown immediately.
<b>WARNING</b>	SMART T.E.C.	Disk <slot> S.M.A.R.T. Threshold Exceed Condition occurred for attribute <item>.
<b>WARNING</b>	SMART failure	Disk <slot>: Failure to get S.M.A.R.T

		information.
--	--	--------------

□ **RMS events**

Level	Type	Description
<b>INFO</b>	Console Login	<username> login from <IP or serial console> via Console UI.
<b>INFO</b>	Console Logout	<username> logout from <IP or serial console> via Console UI.
<b>INFO</b>	Web Login	<username> login from <IP> via Web UI.
<b>INFO</b>	Web Logout	<username> logout from <IP> via Web UI.

□ **LVM2 events**

Level	Type	Description
<b>INFO</b>	VG created	VG <name> has been created.
<b>WARNING</b>	VG creation failed	Failed to create VG <name>.
<b>INFO</b>	VG deleted	VG <name> has been deleted.
<b>INFO</b>	VG renamed	VG <name> has been renamed to <name>.
<b>INFO</b>	UDV created	UDV <name> has been created.
<b>WARNING</b>	UDV creation failed	Failed to create UDV <name>.
<b>INFO</b>	UDV deleted	UDV <name> has been deleted.
<b>INFO</b>	UDV renamed	Name of UDV <name> has been renamed to <name>.
<b>INFO</b>	Read-only caching enabled	Cache policy of UDV <name> has been set as read only.
<b>INFO</b>	Writeback caching enabled	Cache policy of UDV <name> has been set as write-back.
<b>INFO</b>	Write-through caching enabled	Cache policy of UDV <name> has been set as write-through.
<b>INFO</b>	UDV extended	Size of UDV <name> extends.
<b>INFO</b>	LUN attached	UDV <name> has been LUN-attached.
<b>INFO</b>	LUN attachment failed	Failed to attach LUN to UDV <name>.
<b>INFO</b>	LUN detached	UDV <name> has been detached.
<b>INFO</b>	LUN detachment failed	Failed to attach LUN from bus <number>, SCSI ID <number>, lun <number>.

<b>INFO</b>	UDV initialization started	UDV <name> starts initialization.
<b>INFO</b>	UDV initialization finished	UDV <name> completes the initialization.
<b>WARNING</b>	UDV initialization failed	Failed to complete initialization of UDV <name>.
<b>INFO</b>	UDV rebuild started	UDV <name> starts rebuilding.
<b>INFO</b>	UDV rebuild finished	UDV <name> completes rebuilding.
<b>WARNING</b>	UDV rebuild failed	Failed to complete rebuild of UDV <name>.
<b>INFO</b>	UDV migration started	UDV <name> starts migration.
<b>INFO</b>	UDV migration finished	UDV <name> completes migration.
<b>ERROR</b>	UDV migration failed	Failed to complete migration of UDV <name>.
<b>INFO</b>	VG migration started	VG <name> starts migration.
<b>INFO</b>	VG migration finished	VG <name> completes migration.
<b>INFO</b>	UDV rewrite started	Rewrite at LBA <address> of UDV %s starts.
<b>INFO</b>	UDV rewrite finished	Rewrite at LBA <address> of UDV %s completes.
<b>WARNING</b>	UDV rewrite failed	Rewrite at LBA <address> of UDV %s failed.
<b>WARNING</b>	VG degraded	VG <name> is under degraded mode.
<b>WARNING</b>	UDV degraded	UDV <name> is under degraded mode.
<b>ERROR</b>	VG failed	VG <name> is failed.
<b>ERROR</b>	UDV failed	UDV <name> is failed.
<b>ERROR</b>	Recoverable read error occurred	Recoverable read error occurred at LBA <address>-<address> of UDV <name>.
<b>ERROR</b>	Recoverable write error occurred	Recoverable write error occurred at LBA <address>-<address> of UDV <name>.
<b>ERROR</b>	Unrecoverable read error occurred	Unrecoverable read error occurred at LBA <address>-<address> of UDV <name>.
<b>ERROR</b>	Unrecoverable write error occurred	Unrecoverable write error occurred at LBA <address>-<address> of UDV <name>.
<b>ERROR</b>	PD config read failed	Config read failed at LBA <address>-<address> of PD <slot>.

<b>ERROR</b>	PD config write failed	Config write failed at LBA <address>-<address> of PD <slot>.
<b>ERROR</b>	Global CV adjustment failed	Failed to change size of the global cache.
<b>INFO</b>	Global cache OK	The global cache is ok.
<b>ERROR</b>	Global CV creation failed	Failed to create the global cache.
<b>INFO</b>	Dedicated spare configured	PD <slot> has been configured to VG <name> as a dedicated spare disk.
<b>INFO</b>	Global spare configured	PD <slot> has been configured as a global spare disk.
<b>ERROR</b>	PD read error occurred	Read error occurred at LBA <address>-<address> of PD <slot>.
<b>ERROR</b>	PD write error occurred	Write error occurred at LBA <address>-<address> of PD <slot>.
<b>INFO</b>	PD freed	PD <slot> has been removed from VG <name>.
<b>INFO</b>	VG imported	Configuration of VG<name> has been imported.
<b>INFO</b>	VG restored	Configuration of VG <name> has been restored.
<b>INFO</b>	UDV restored	Configuration of UDV <name> has been restored.

□ **iSCSI events**

Level	Type	Description
<b>INFO</b>	iSCSI login succeeds	iSCSI login from <IP> succeeds.
<b>INFO</b>	iSCSI login rejected	iSCSI login from <IP> was rejected, reason [<string>]
<b>INFO</b>	iSCSI logout	iSCSI logout from <IP> was received, reason [<string>].

□ **Battery backup events**

Level	Type	Description
<b>INFO</b>	BBM sync data	Abnormal shutdown detected, start flushing battery-backed data (<number> KB).
<b>INFO</b>	BBM sync data	Abnormal shutdown detected, flushing battery-

		backup data finishes.
<b>INFO</b>	BBM detected	Battery backup module is detected.
<b>INFO</b>	BBM is good	Battery backup module is good.
<b>INFO</b>	BBM is charging	Battery backup module is charging.
<b>WARNING</b>	BBM is failed	Battery backup module is failed.
<b>INFO</b>	BBM	Battery backup feature is <item>.

□ **JBOD events**

Level	Type	Description
<b>INFO</b>	Disk inserted	JBOD <number> disk <slot> is inserted into system.
<b>Warning</b>	Disk removed	JBOD <number> disk <slot> is removed from system.
<b>ERROR</b>	HDD failure	JBOD <number> disk <slot> is disabled.
<b>INFO</b>	JBOD inserted	JBOD <number> is inserted into system
<b>WARNING</b>	JBOD removed	JBOD <number> is removed from system
<b>WARNING</b>	SMART T.E.C	JBOD <number> disk <slot>: S.M.A.R.T. Threshold Exceed Condition occurred for attribute %s
<b>WARNING</b>	SMART Failure	JBOD <number> disk <slot>: Failure to get S.M.A.R.T information
<b>INFO</b>	Dedicated spare configured	JBOD <number> PD <slot> has been configured to RG <name> as a dedicated spare disk.
<b>INFO</b>	Global spare configured	JBOD <number> PD <slot>d has been configured as a global spare disk.
<b>WARNING</b>	PD read error occurred	Read error occurred at LBA <address>-<address> of JBOD <number> PD <slot>.
<b>WARNING</b>	PD write error occurred	Write error occurred at LBA <address>-<address> of JBOD <number> PD <slot>.
<b>INFO</b>	PD freed	JBOD <number> PD <slot> has been removed from RG <name>.

□ **System maintenance events**

Level	Type	Description

<b>INFO</b>	System shutdown	System shutdown.
<b>INFO</b>	System reboot	System reboot.
<b>INFO</b>	FW upgrade start	Firmware upgrade start.
<b>INFO</b>	FW upgrade success	Firmware upgrade success.
<b>WARNING</b>	FW upgrade failure	Firmware upgrade failure.

## C. Known issues

1. Microsoft MPIO is not supported on Windows XP or Windows 2000 Professional.

**Workaround solution:** Using Windows Server 2003 or Windows 2000 server to run MPIO.

## D. Microsoft iSCSI Initiator

Here is the step by step to setup Microsoft iSCSI Initiator. Please visit Microsoft website for latest iSCSI initiator. The following setup may not use the latest Microsoft iSCSI initiator.

1. Run Microsoft iSCSI Initiator.
2. Click "**Discovery**".
3. Click "**Add**". Input IP address or DNS name of iSCSI storage device.



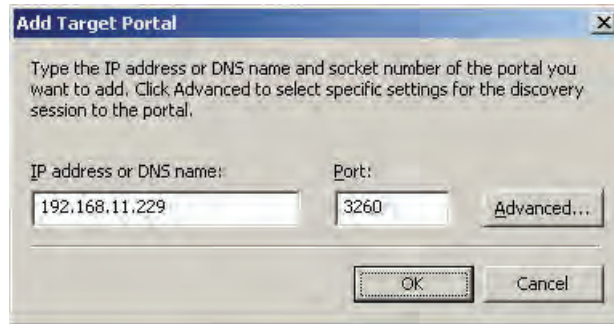

Figure D.2

4. Click "OK".
5. Click "Targets".

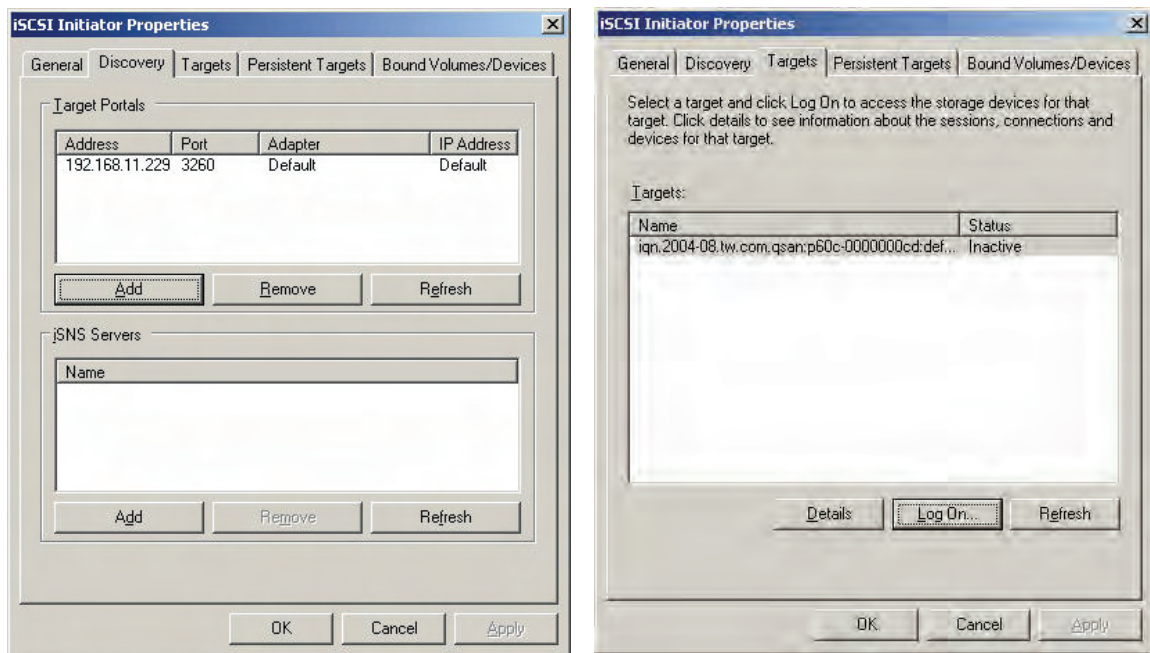

Figure D.3

6. Click "Log On". Check "Enable multi-path" if running MPIO.

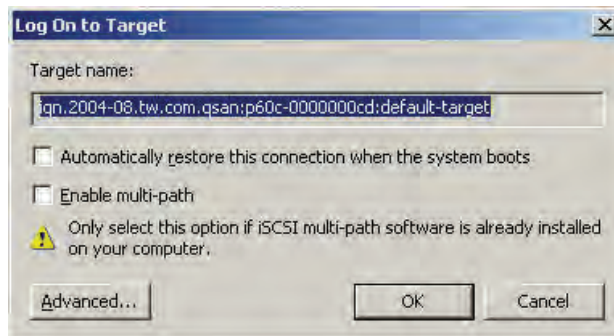

Figure D.4

7. Click “**Advance...**” if CHAP information is needed.
8. Click “**OK**”. The status would be “**Connected**”.
9. Done, it can connect to an iSCSI disk.

The following procedure is to log off iSCSI device.

1. Click “**Details**” in “**Targets**”.
2. Check the Identifier, which will be deleted.
3. Click “**Log off**”.
4. Done, the iSCSI device log off successfully.

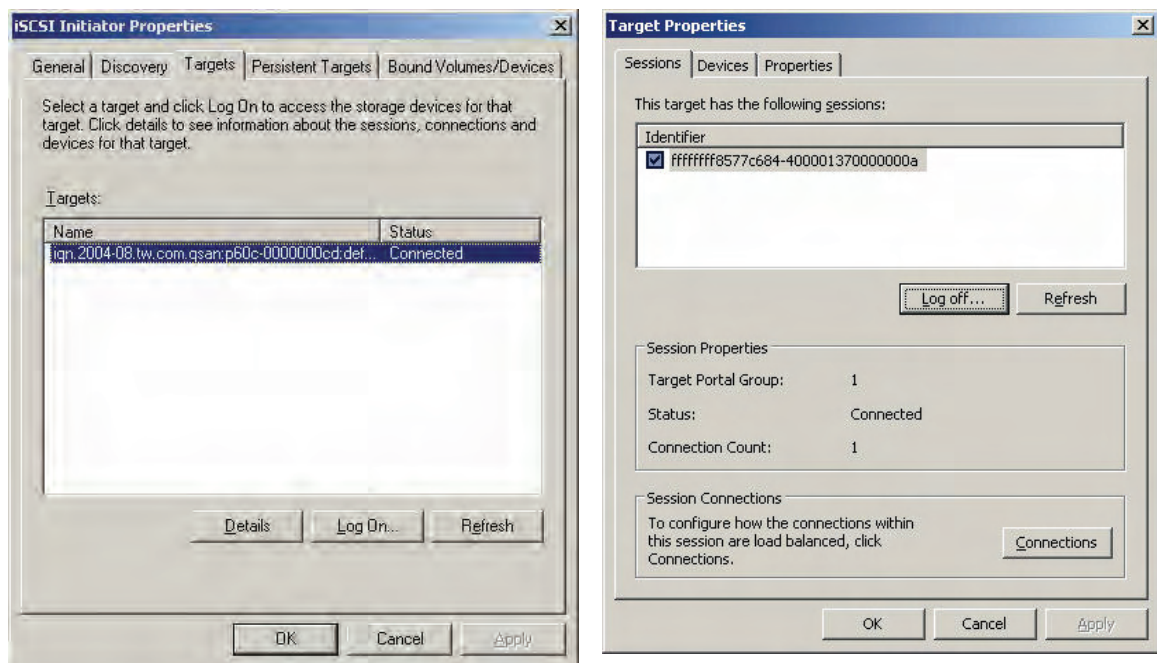

Figure D.5

## E. Installation steps for large volume (TB)

### Introduction:

**iStarUSA iSCSI Series** are capable of supporting large volumes (>2TB). When connecting iStarUSA iSCSI Storage to 64bit OS installed host/server, the host/server is inherently capable for large volumes from the 64bit address. On

the other side, if the host/server is installed with 32bit OS, user has to change the block size to 1KB, 2KB or 4KB to support volumes up to 4TB, 8TB or 16TB, for the 32bit host/server is not LBA (Logical Block Addressing) 64bit supported. For detail installation steps, please refer to following steps below.

### Step 1: Configure target

1. Prepare the hard drivers which has a capacity over 2TB. Follow the example in chapter 3 to create a VG/UDV. Then attach LUN.



**Tips**  
If the OS is 64bit, user can set the block size to any available value. If the OS is 32bit, user must change the block size to larger values than 512B. There will be a confirmation pop-up

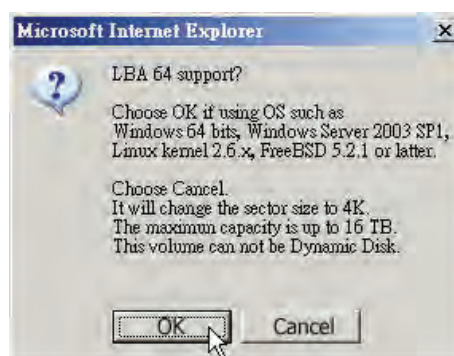

Figure E.1:

(Figure G.1: choose “OK” for 64bit OS, choose “Cancel” for 32bit OS, this step will change block size to 4K automatically.)

2. Click the button “  ” in “No.” column to see “**More information**”. Look at block size is 512B for 64bit OS setting, 4K for 32bit OS setting.

### Step 2: Configure host/server

1. Follow the installation guild provided by HBA vendor, install HBA

driver properly. For iSCSI models, please install the latest Microsoft iSCSI initiator from the link below.

<http://www.microsoft.com/downloads/details.aspx?FamilyID=12cb3c1a-15d6-4585-b385-befd1319f825&DisplayLang=en>

### Step 3: Initialize/Format/Mount the disk

1. Go to Start → Control Panel → Computer Management → Disk Management, it displays a new disk.

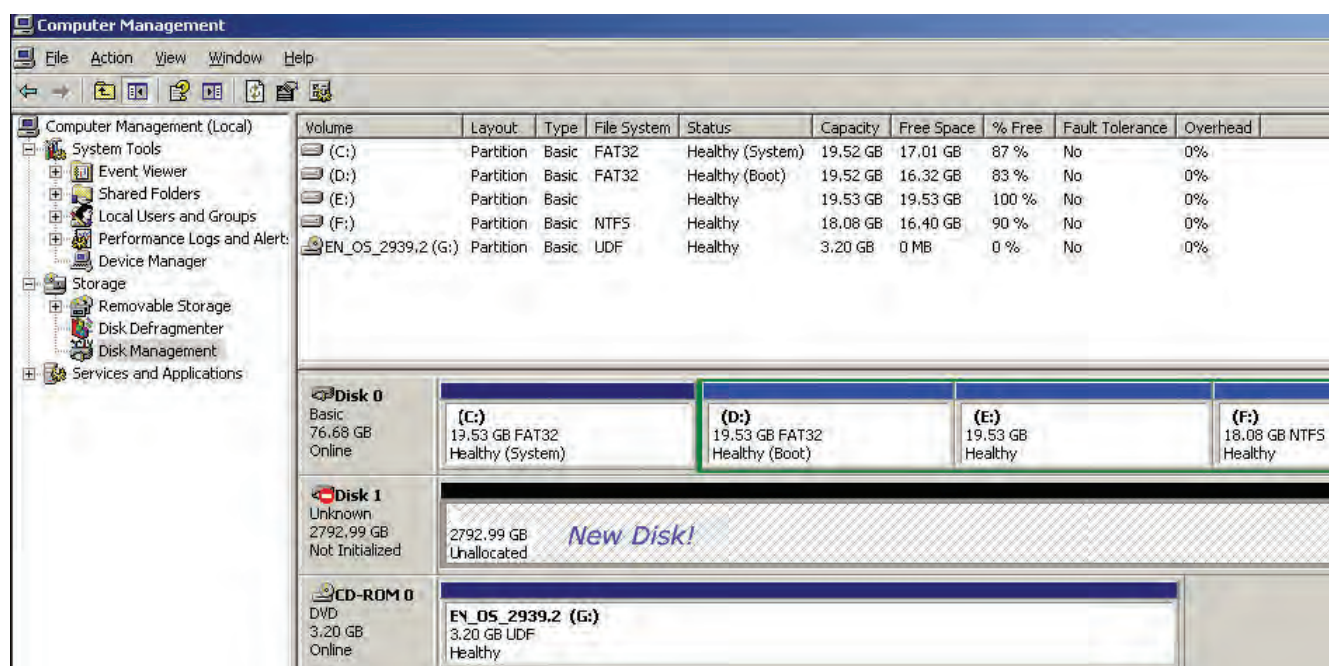

Figure E.2

2. Initialize the disk.



Figure E.3

3. Convert to GPT disk for over 2TB capacity. For more detail



information about GPT, please visit

[http://www.microsoft.com/whdc/device/storage/GPT\\_FAQ.aspx](http://www.microsoft.com/whdc/device/storage/GPT_FAQ.aspx)



Figure E.4

4. Format the disk.



Figure E.5

5. Done.

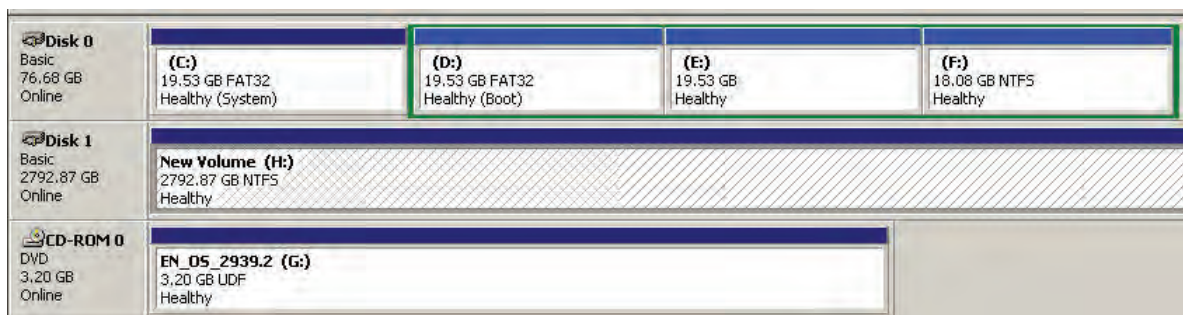

Figure E.6

6. The new disk is ready to use, the available size = 2.72TB.

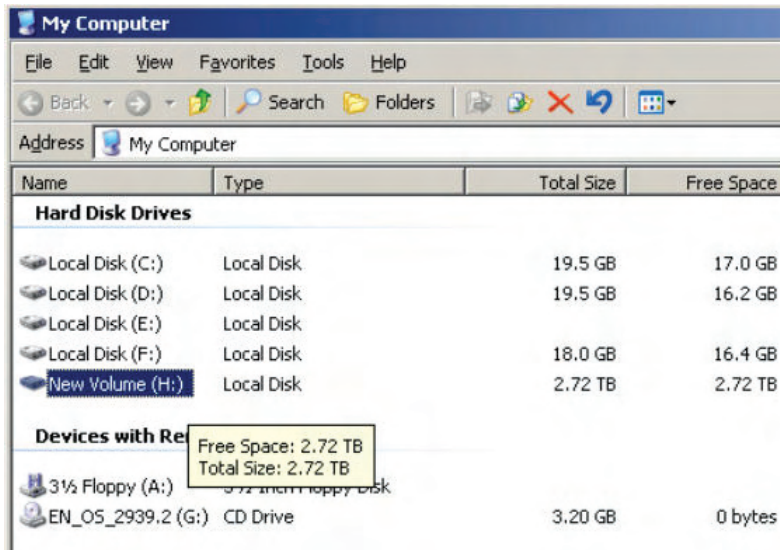



Figure E.7



**Caution**  
 If user setups 512B block size for VD and the host/server OS is 32bit, in the last step of formatting disk, user will find OS

- Wrong setting result: OS can not format disk sector after 2048GB(2TB).

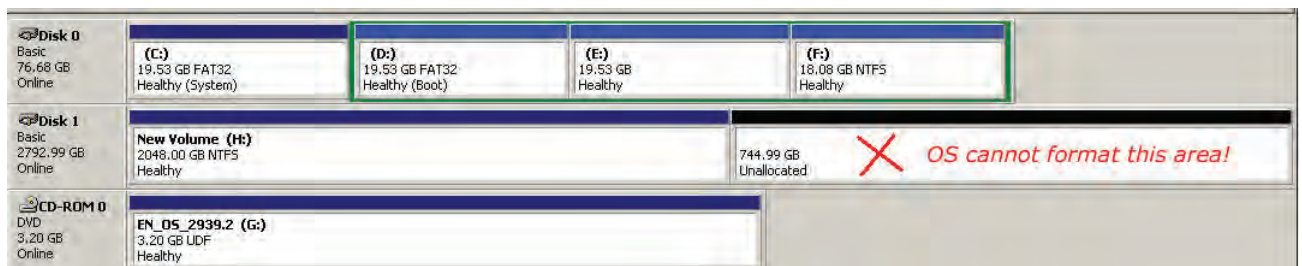

Figure E.8

## F. MPIO and MC/S setup instructions

Here is the instruction to setup MPIO or MC/S. The following network diagrams are the examples. Please follow them to setup the environment. Remind that host must have multi NICs which are set up as different IPs.

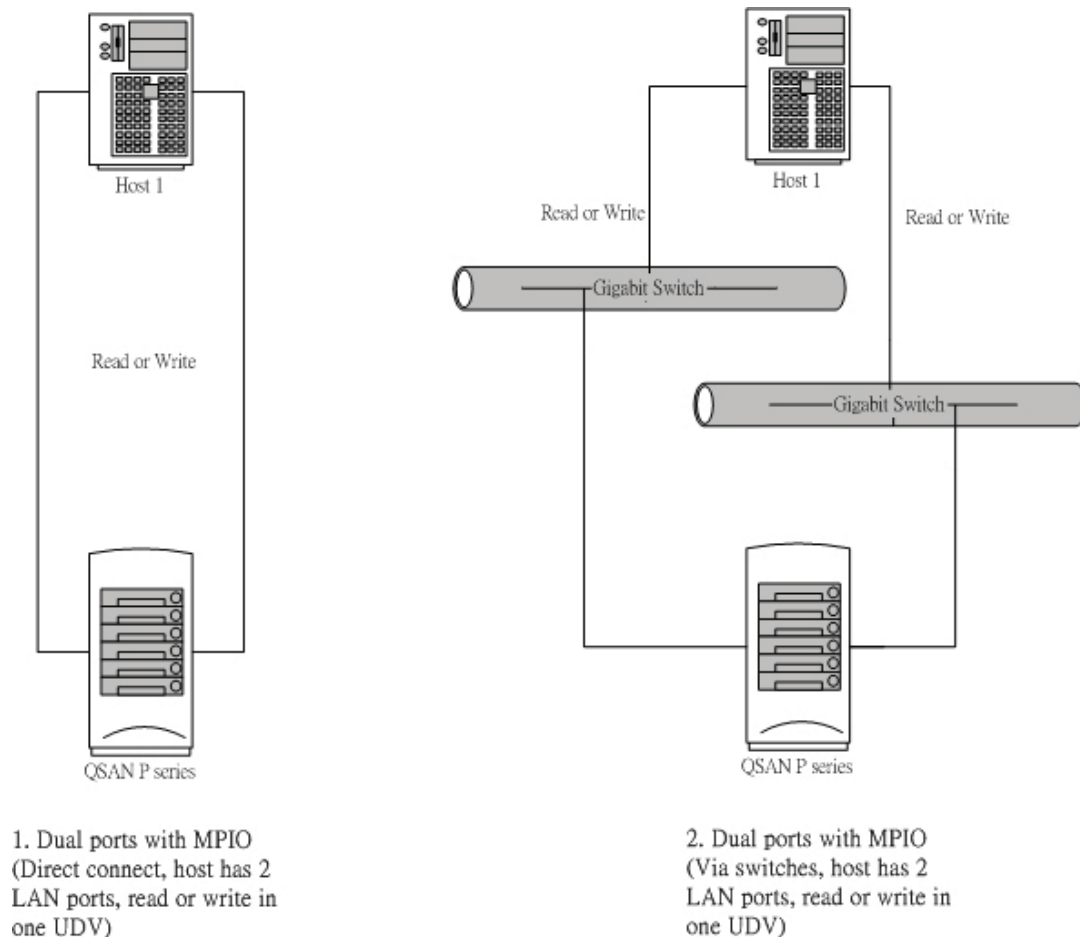

Figure F.1

The MPIO setup instructions are in the following:

1. Create VG/UDV, and then attach LUN.
2. Add the first “Target Portal” on Microsoft iSCSI initiator.
3. Add the second “Target Portal” on Microsoft iSCSI initiator.
4. Logon.
5. Enable “**Enable multi-path**” checkbox. Then click “**Advanced...**”.
6. Select the first “Source IP” and “Target Portal” to iSCSI data port 1. Then click “**OK**”.
7. Logon again.
8. Enable “**Enable multi-path**” checkbox. Then click “**Advanced...**”.

9. Select the second "Source IP" and "Target Portal" to iSCSI data port 2. Then click "**OK**".
10. iSCSI device is connected. Click "**Details**".
11. Click "**Device**" tab, then click "**Advanced**".
12. Click "**MPIO**" tab, select "**Load Balance Policy**" to "**Round Robin**".
13. Click "**Apply**".
14. Run "**Device Manage**" in Windows. Make sure MPIO device is available.
15. Done.

The MC/S setup instructions are in the following:

1. Create VG/UDV, and then attach LUN.
2. Add the first "Target Portal" on Microsoft iSCSI initiator, For MC/S, there is only ONE "**Target Portals**" in the "**Discovery**" tab.
3. Logon.
4. Then click "**Advanced...**".
5. Select the first "Source IP" and "Target Portal" to iSCSI data port 1. Then click "**OK**".
6. After connected, click "**Details**", then in the "**Session**" tab, click "**Connections**".
7. Choose "**Round Robin**" in "**Load Balance Policy**".
8. "**Add**" Source Portal for the iSCSI data port 2.
9. Select the second "Source IP" and "Target Portal" to iSCSI data port 2. Then select "**OK**".
10. Done.

### System information

	iAge820-iSCSI/ mAge208U20-iSCSI/ mAge316U20-iSCSI
<b>SW version</b>	2.3.1