

4

3

2

1

D

D

C

C

B

B

A

A

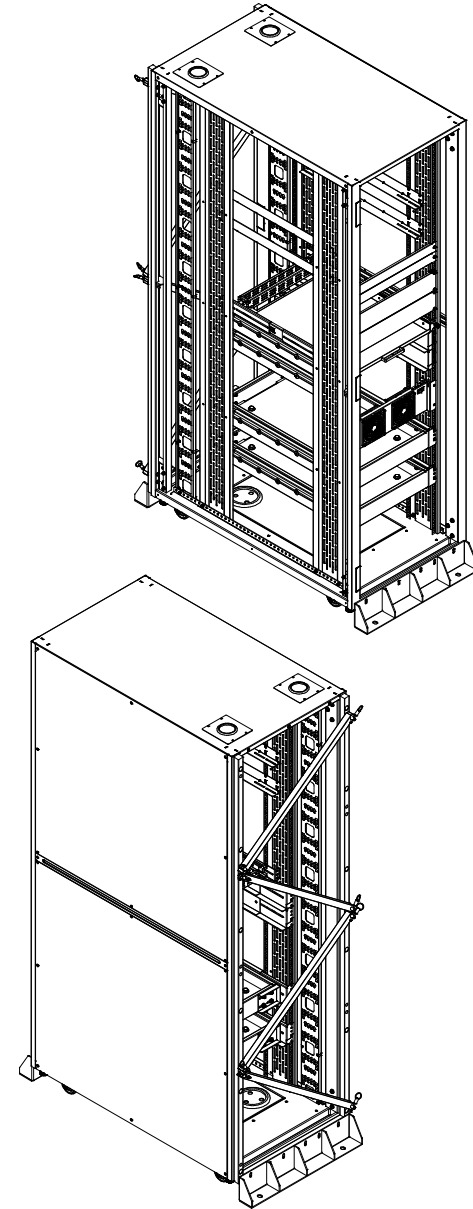
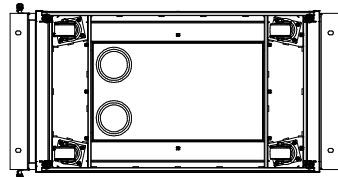
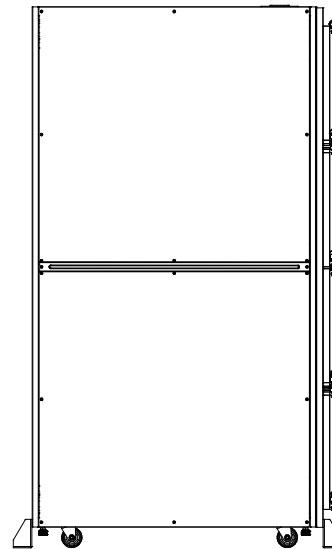
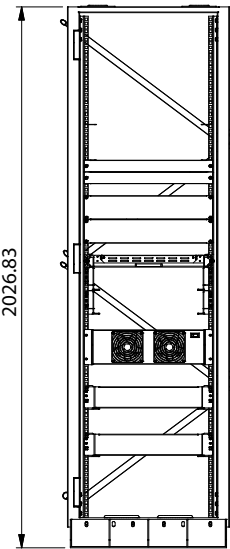
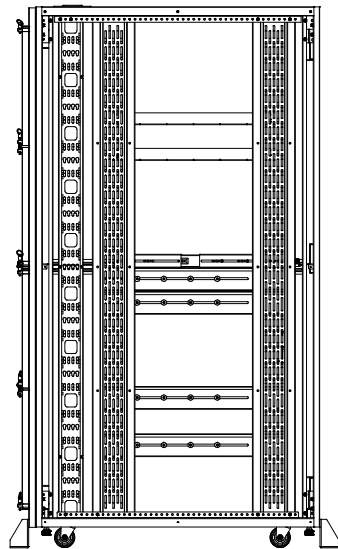
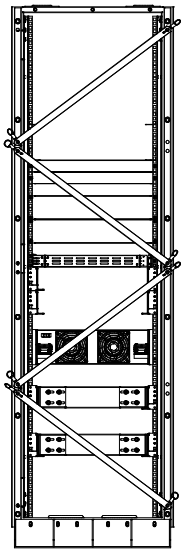
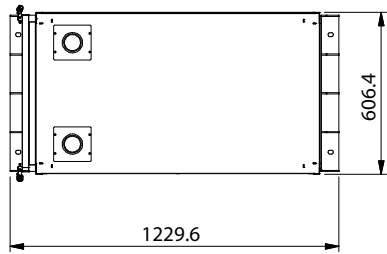

PROPRIETARY AND CONFIDENTIAL
 THE INFORMATION CONTAINED IN THIS
 DRAWING IS THE SOLE PROPERTY OF
 ISTARUSA GROUP. ANY
 REPRODUCTION IN PART OR AS A WHOLE
 WITHOUT THE WRITTEN PERMISSION OF
 ISTARUSA GROUP IS
 PROHIBITED.

| | | | | | | | |
|-----------|--|------------------------|--|------------------------------------|--|--|--|
| | | DIMENSIONS ARE IN MM | | NAME | | DATE | |
| | | TOLERANCES: | | DRAWN | | | |
| | | FRACTIONAL ± | | CHECKED | | | |
| | | ANGULAR: MACH ± BEND ± | | ENG APPR. | | | |
| | | TWO PLACE DECIMAL ± | | MFG APPR. | | | |
| | | THREE PLACE DECIMAL ± | | Q.A. | | | |
| | | MATERIAL | | COMMENTS: | | | |
| NEXT ASSY | | USED ON | | | | | |
| BY | | EA | | | | | |
| | | | | | |  WXE-4210 | |
| | | | | SIZE DWG. NO. A3 AS19001456 | | REV. 2 | |
| | | | | SCALE: .05 WEIGHT: 不适用 | | SHEET : 3 / 3 | |

4

3

2

1

A